

vrib\_trimline-barg\_flush

**Flush Barge For Vertical Rib Profile**  
Cross Section

All dimensions in millimetres  
Scale 1:2  
16/01/12

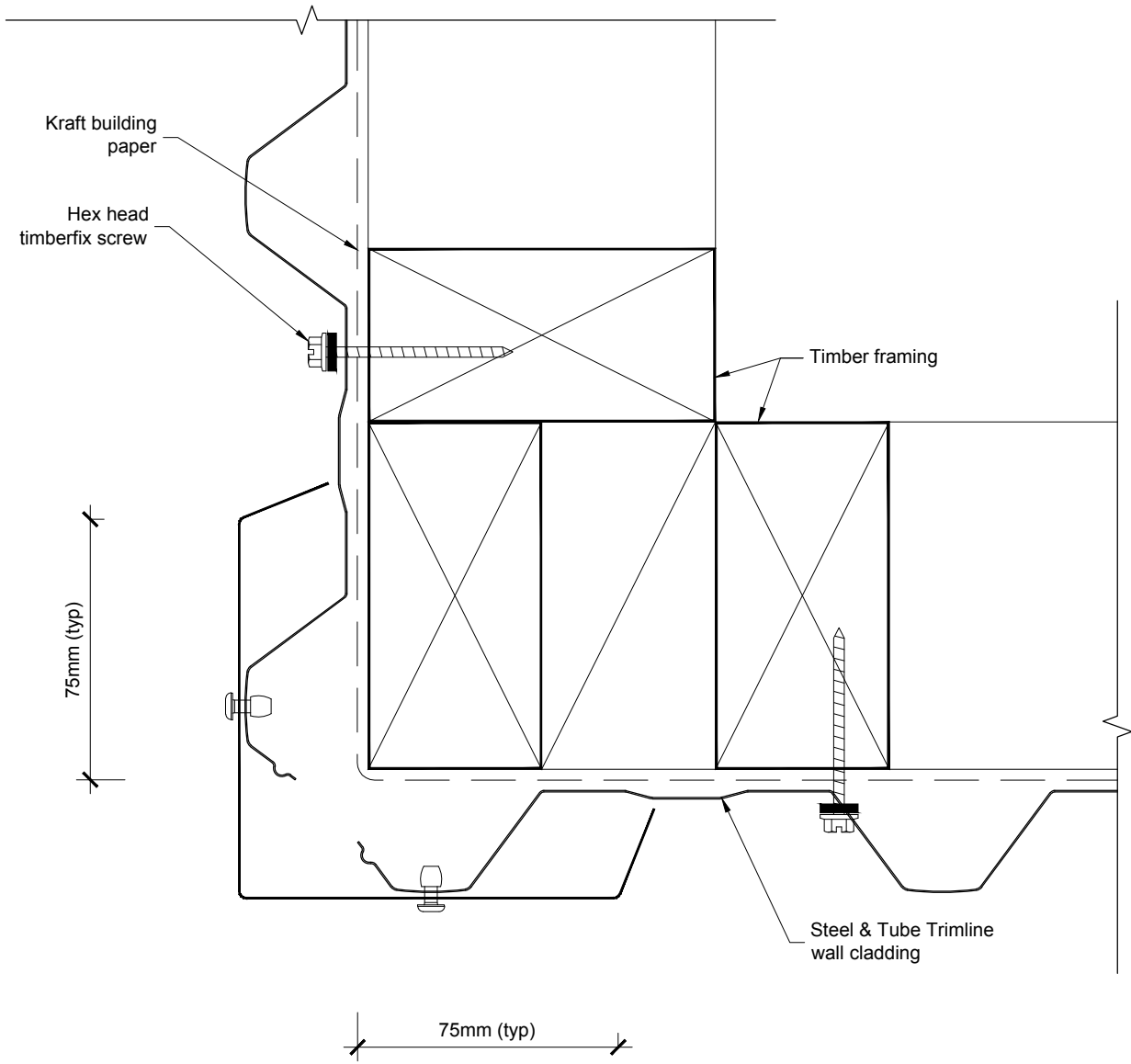

vrib\_trimline-corn\_ext

**Corner Flashing For Vertical Rib Profile  
Cover Flashed External Corner**

All dimensions in millimetres  
Scale 1:2  
16/01/12

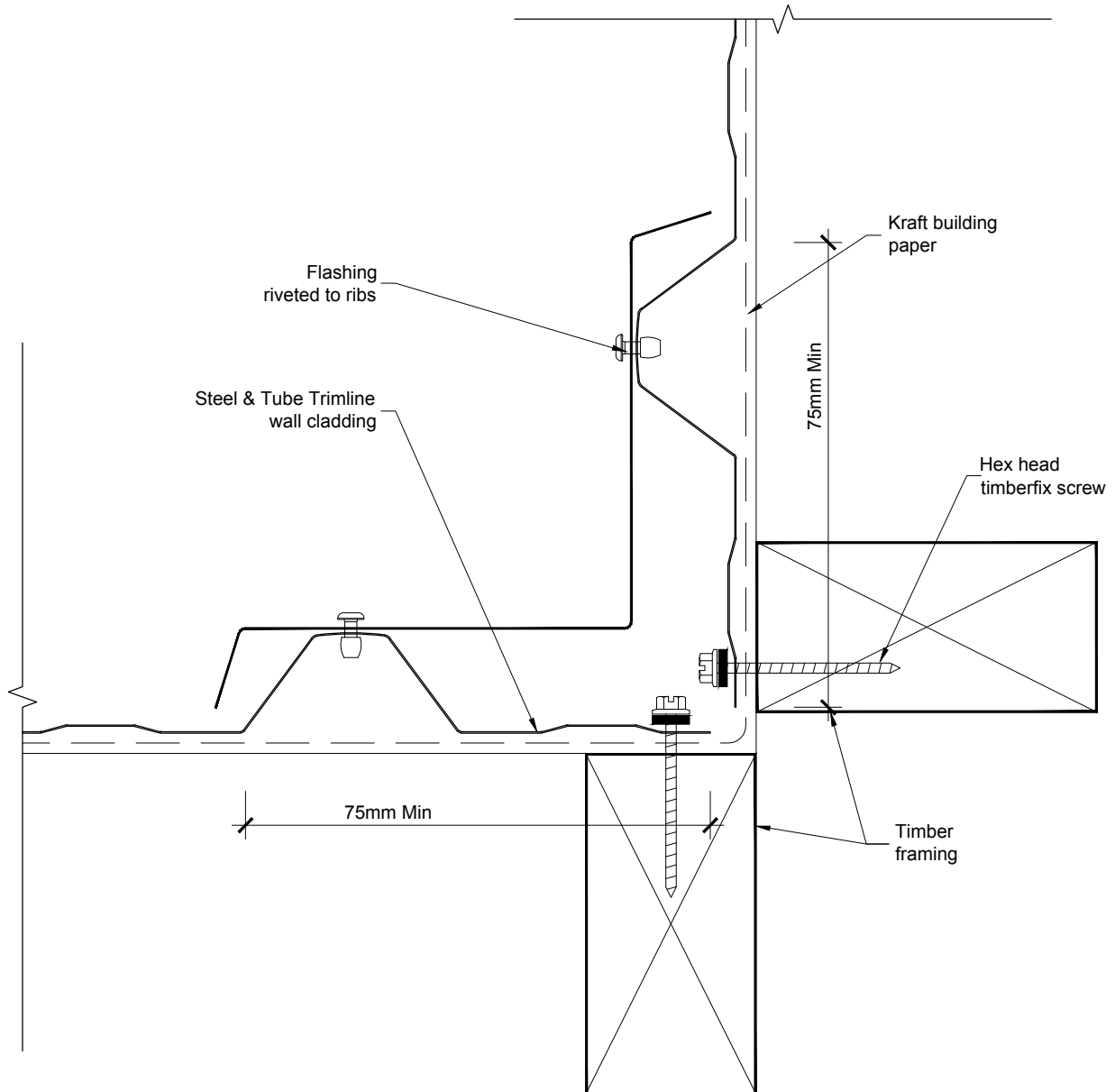

vrib\_trimline-corn\_int

**Internal Corner For Vertical Rib Profile**  
Cross Section

All dimensions in millimetres  
Scale 1:2  
16/01/12

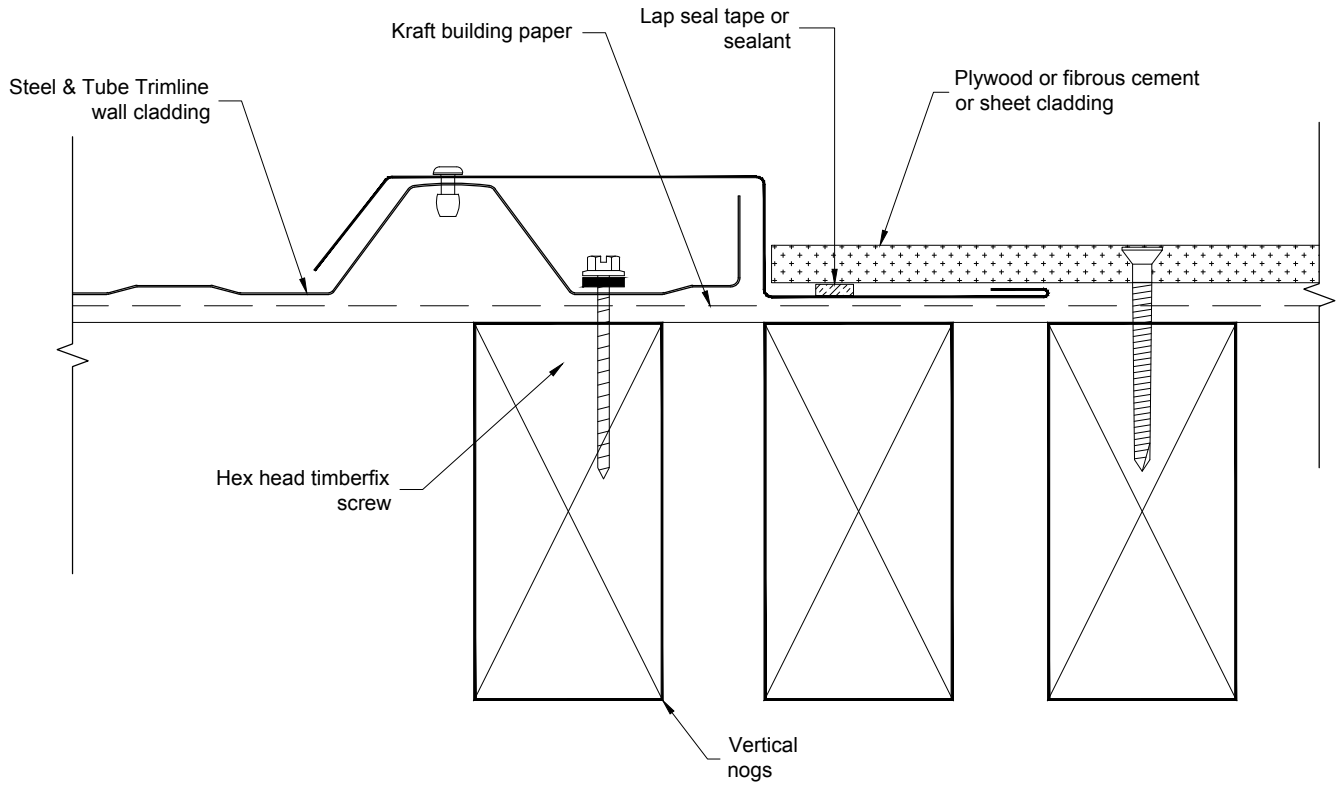

vrib\_trimline-jctn\_vert\_but

**Vertical Butt Joint (for Changes In Cladding Material)**  
Plan

All dimensions in millimetres  
Scale 1:2  
16/01/12

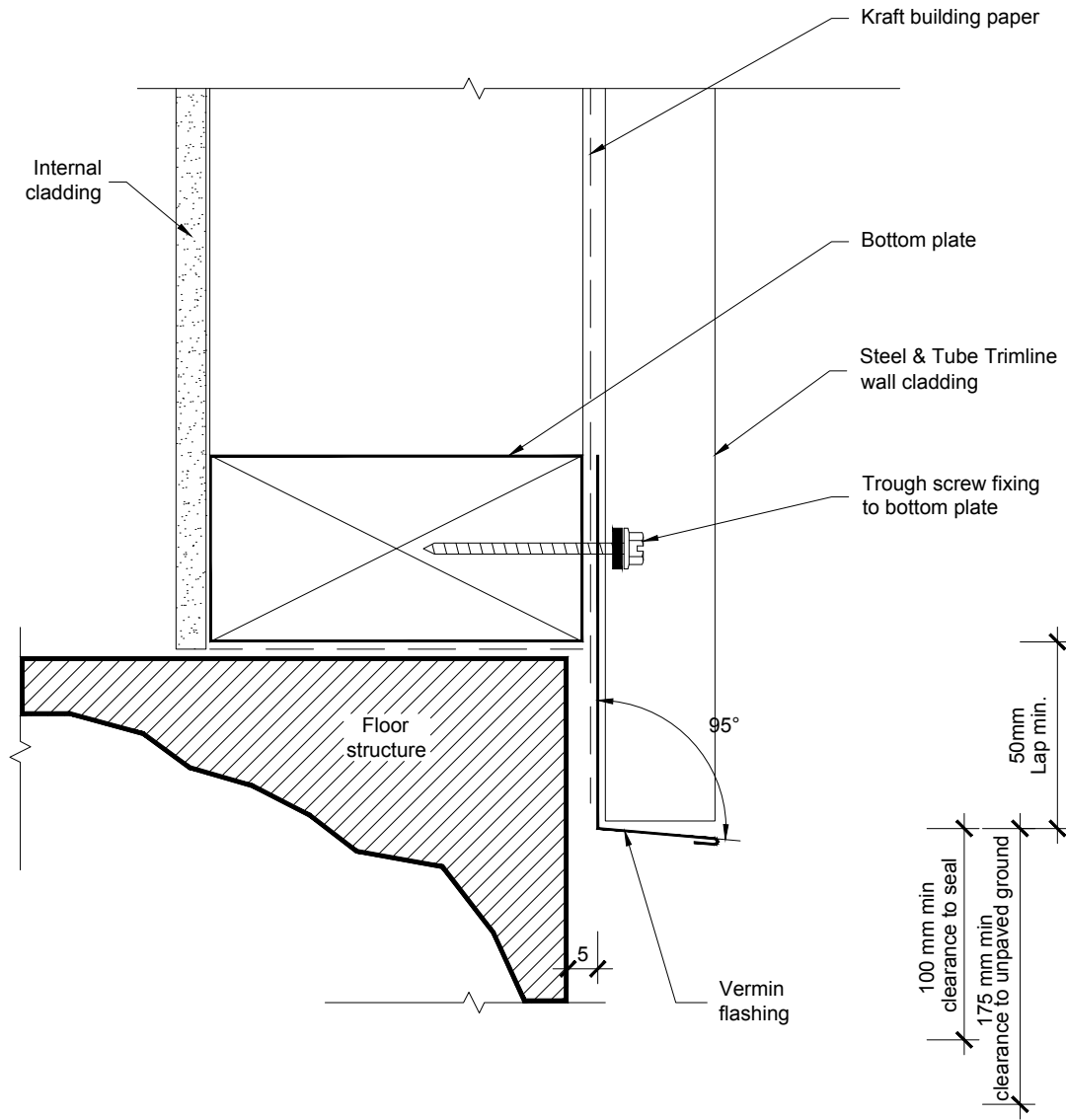

vrib\_trimline-jctn\_wall\_floor

**Bottom Of Cladding For Vertical Rib Profile**  
Cross Section

All dimensions in millimetres  
Scale 1:2  
16/01/12

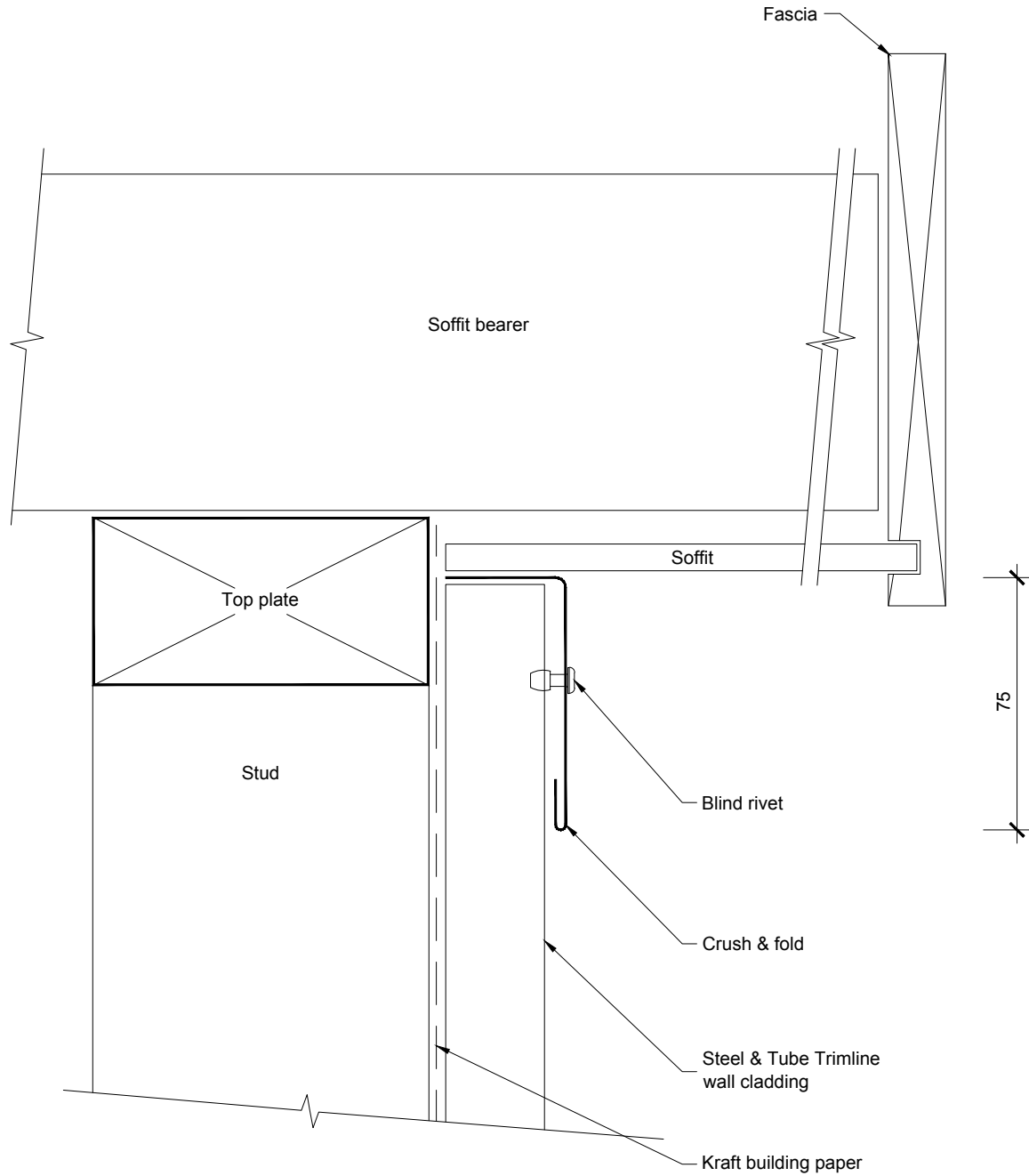

**Note:**

1: For raking soffits, stop end horizontal sheets at the sloping join.

vrib\_trimline-soff\_hori

**Soffit Line - Vertical Rib Profile**  
Cross Section

All dimensions in millimetres  
Scale 1:2  
16/01/12

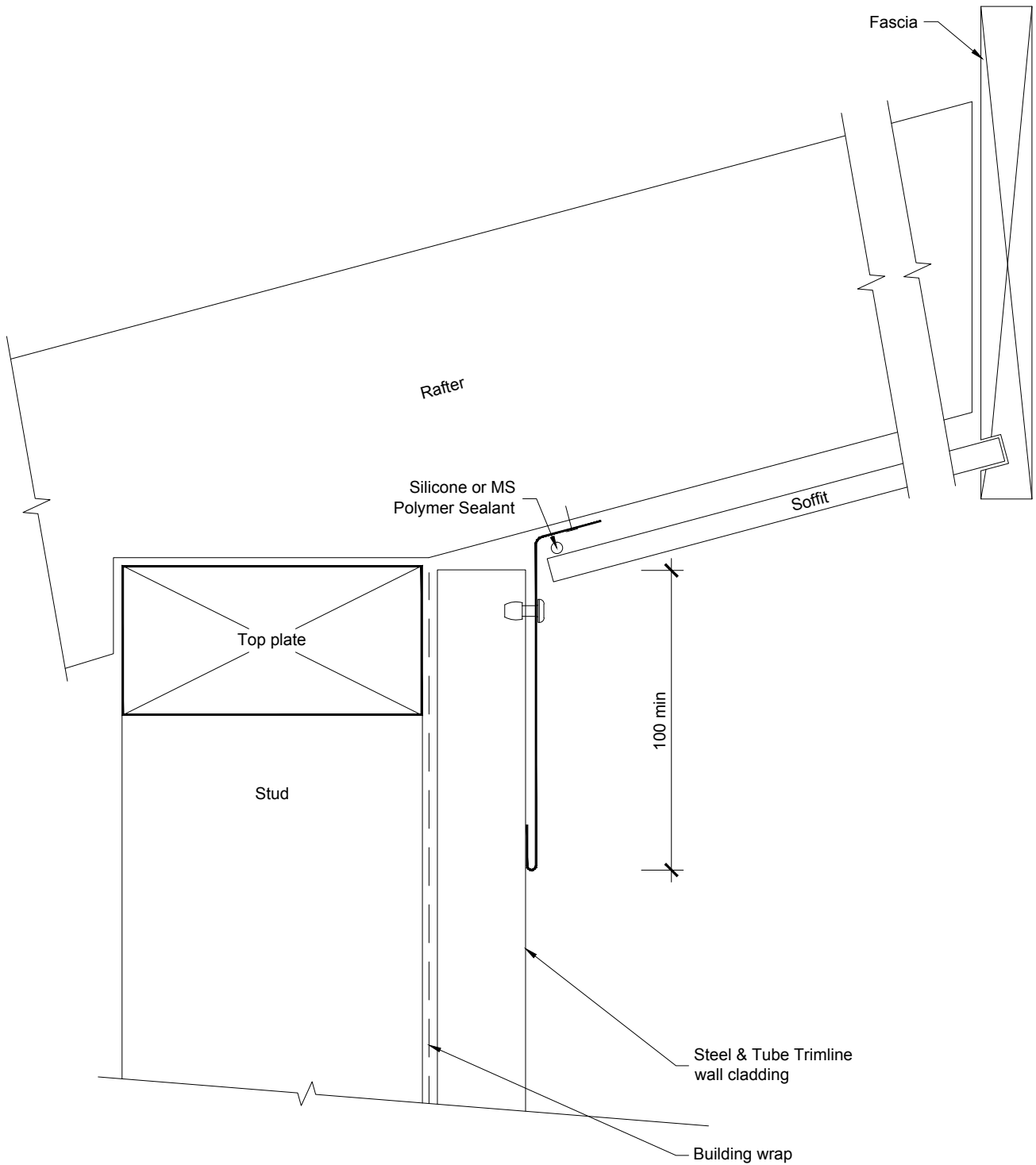

**Note:**

1. Cavity battens containing copper must be separated from steel cladding by building paper, building wrap, DPC/PVC strips or by painting, otherwise use uPVC Cavibat™.
2. For raking soffits, stop end horizontal sheets at the sloping join.

vrib\_trimline-soff\_rake

**Soffit Line - Vertical Rib Profile Sloping Soffit  
Cross Section**

All dimensions in millimetres  
Scale 1:2  
16/01/12

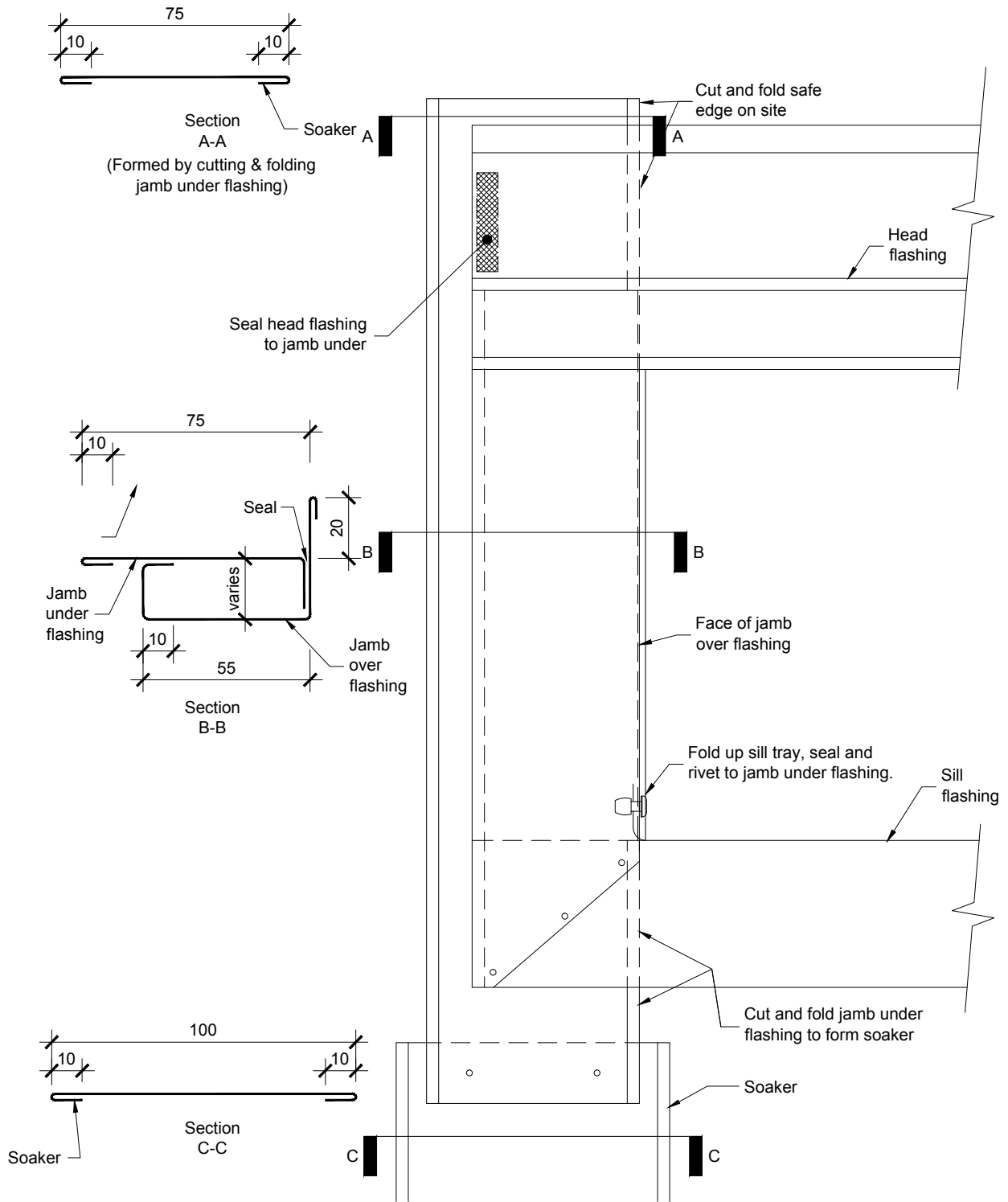

vrib\_trimline-wind\_alum\_dfx\_flash

**Framed Window for Vertical Rib Profile - Direct Fixed**  
Window Flashing Layout Cross Section

All dimensions in millimetres  
Scale 1:2  
16/01/12



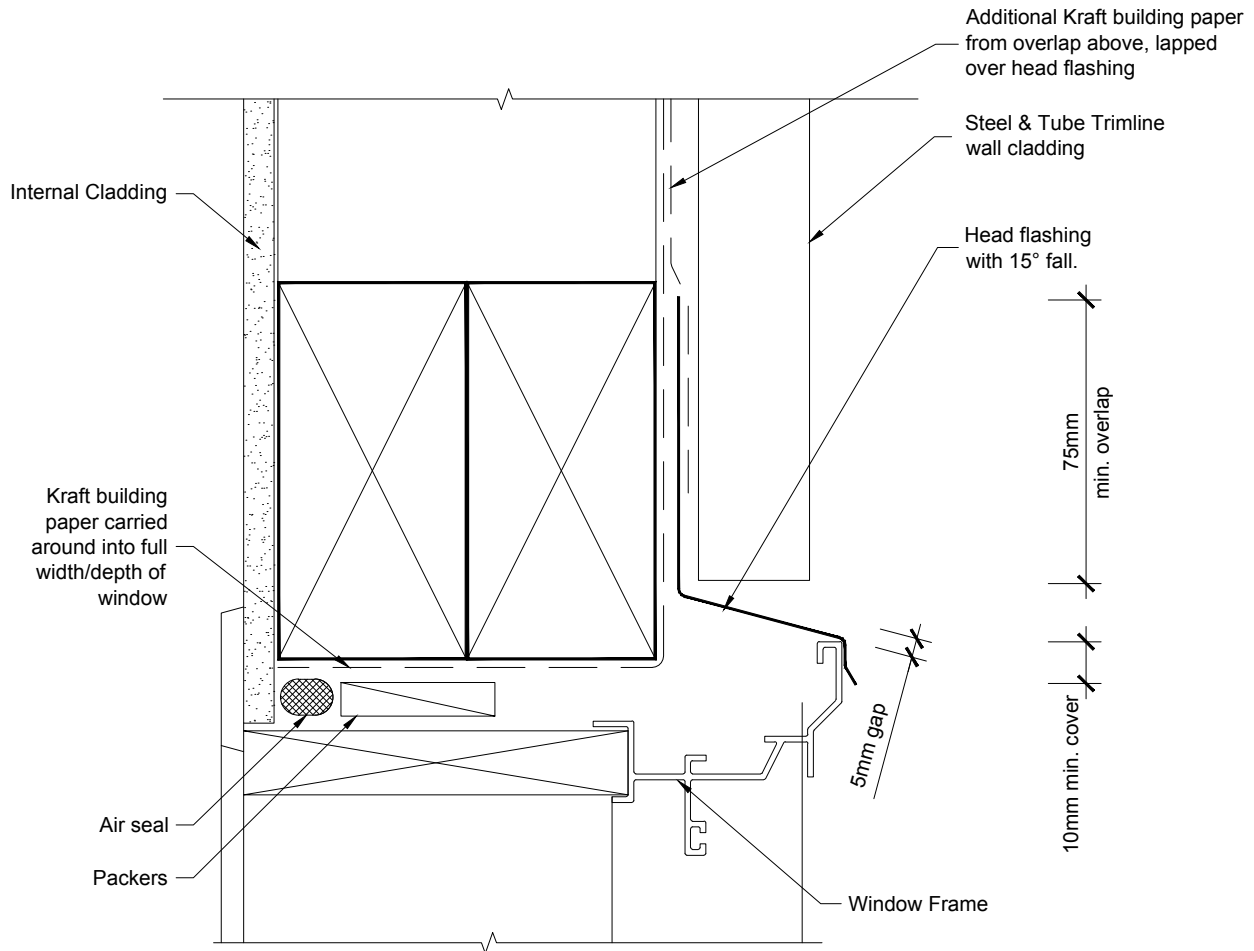

**NOTES:**

1. Architraves are shown for consistency only, detail may be used with rebated liner.

vrib\_trimline-wind\_alum\_dfx\_head

**Framed Window for Vertical Rib Profile  
Head Cross Section**

All dimensions in millimetres  
Scale 1:2  
16/01/12

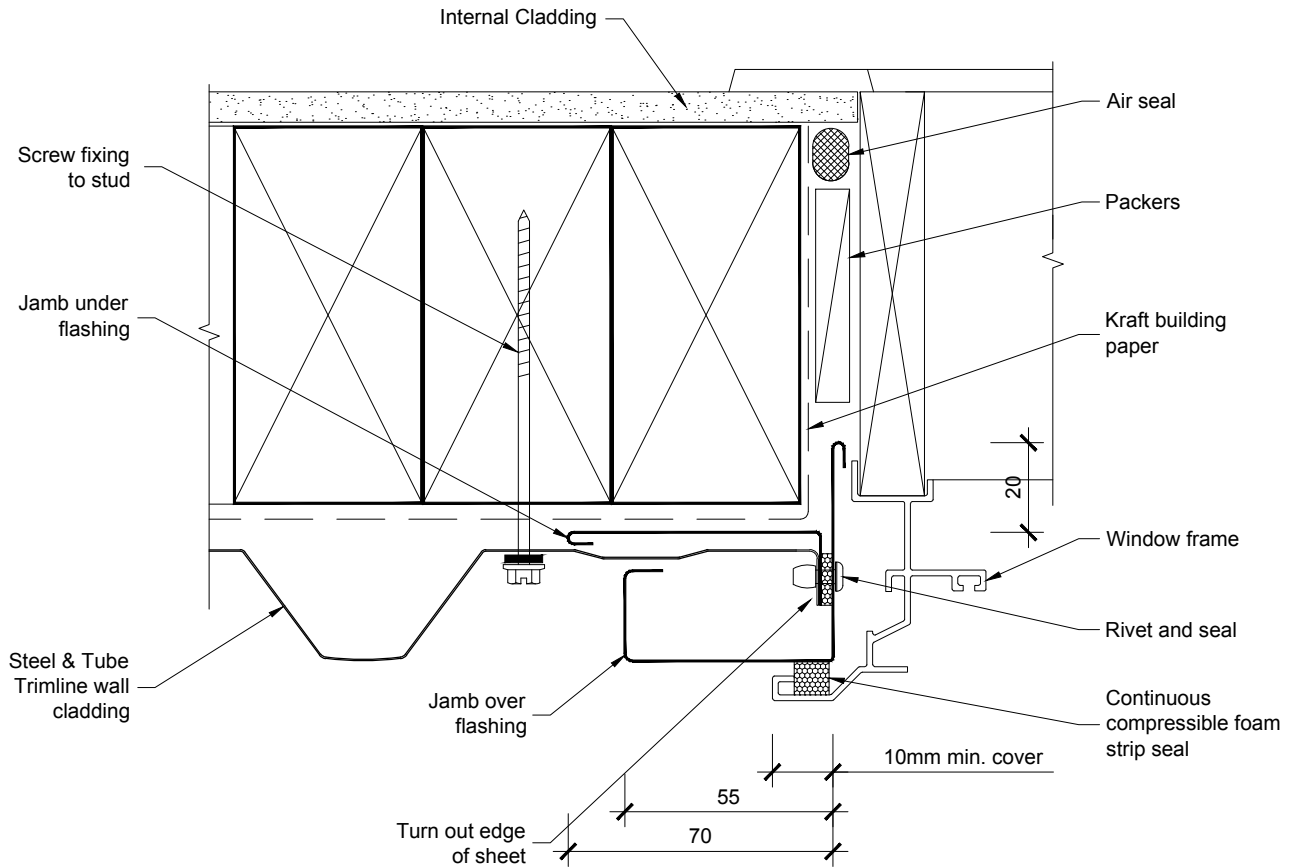

**NOTES:**

1. Window profile to be selected to achieve cover shown in details.
2. Architraves are shown for consistency only, detail may be used with rebated liner.

vrib\_trimline-wind\_alum\_dfx\_jamb

**Framed Window for Vertical Rib Profile  
Jamb Cross Section**

All dimensions in millimetres  
Scale 1:2  
16/01/12

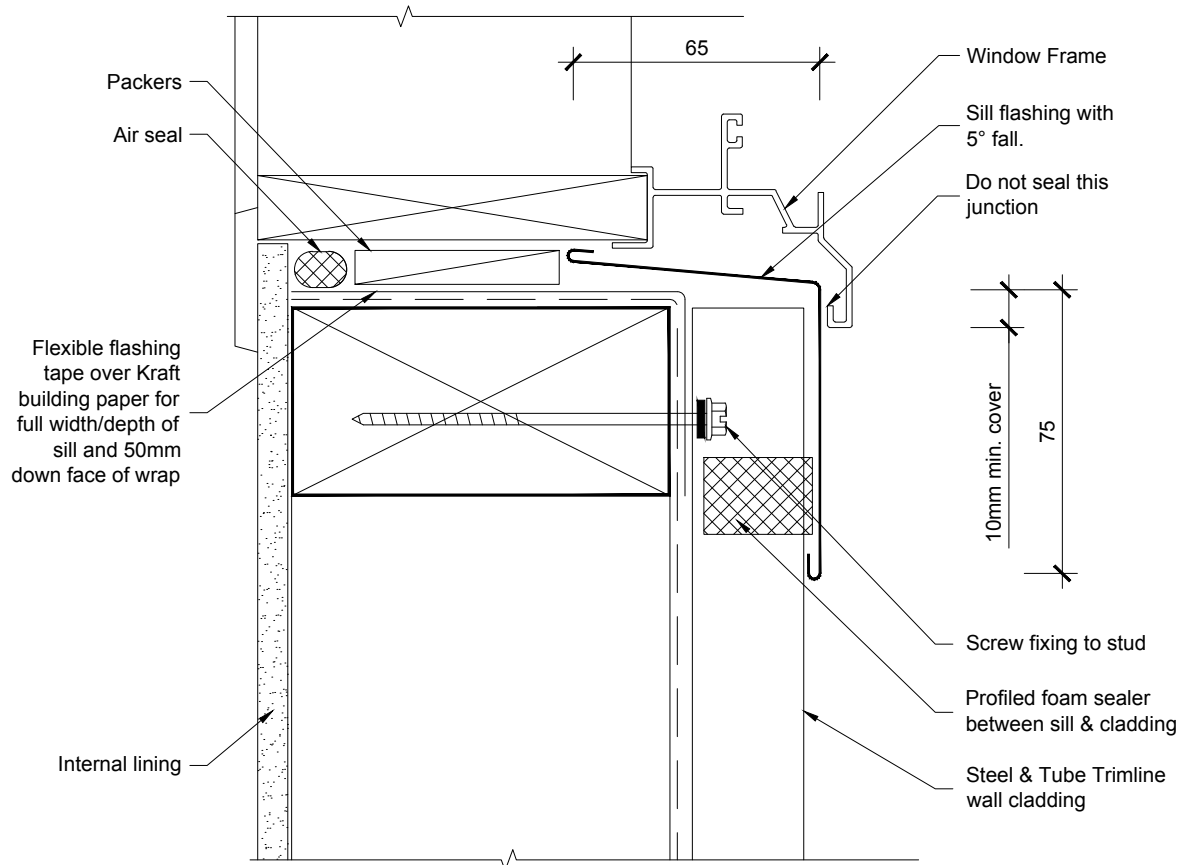

**NOTES:**

- 1: Window profile to be selected to achieve cover shown in details.
- 2: Architraves are shown for consistency only, detail may be used with rebated liner.
- 3: Make allowance between packer at sills for support brackets for large windows. Sash support brackets require specific design, and shall be supplied by the window manufacturer.

vrib\_trimline-wind\_alum\_dfx\_sill

**Framed Window for Vertical Rib Profile**  
Sill Cross Section

All dimensions in millimetres  
Scale 1:2  
16/01/12

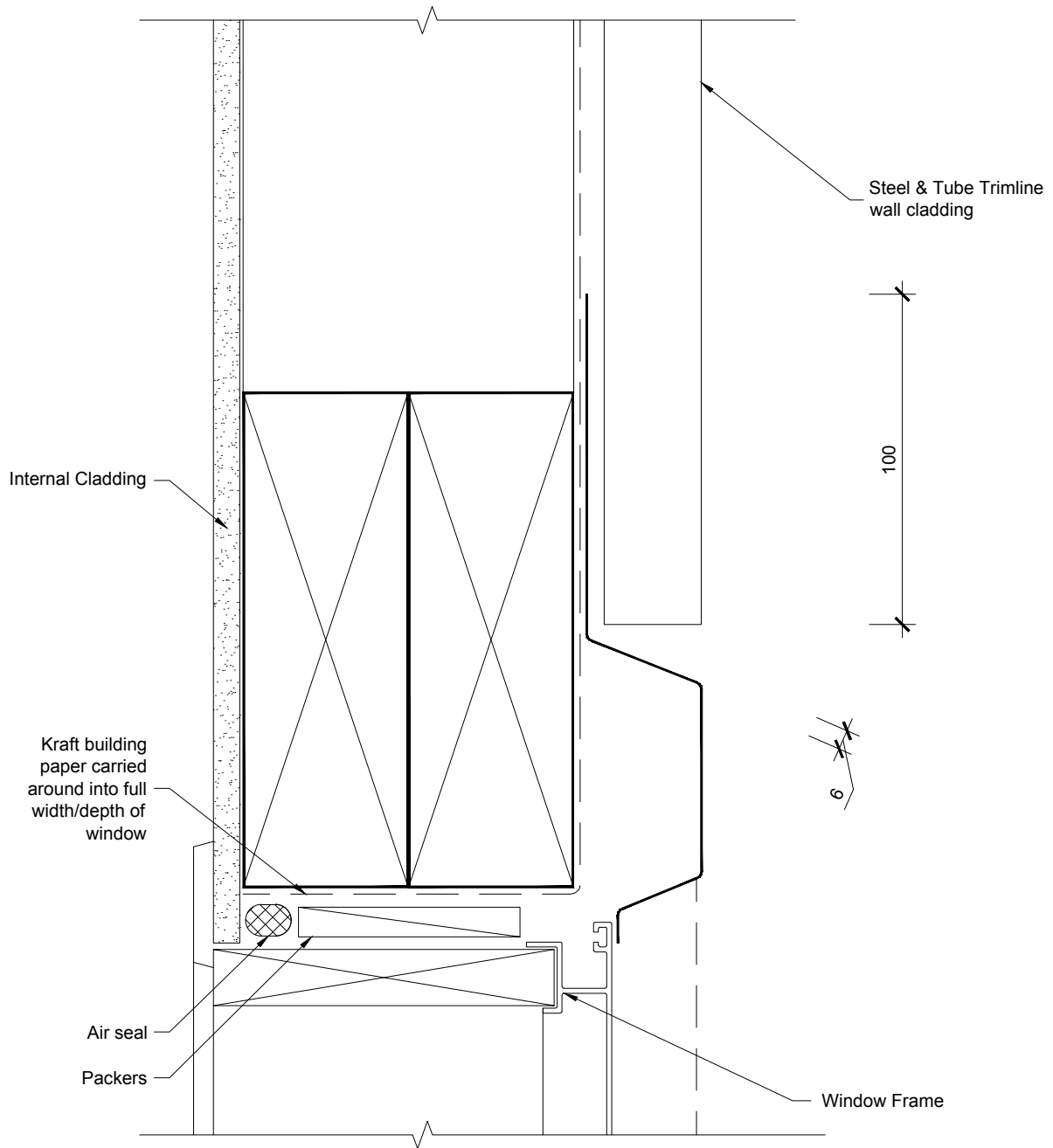

**NOTES:**

- 1: Architraves are shown for consistency only, detail may be used with rebated liner.

vrib\_trimline-wind\_alum\_rece\_head

**Recessed Windows for Vertical Rib Profile - Direct Fixed  
Head Cross Section**

All dimensions in millimetres  
Scale 1:2  
16/01/12

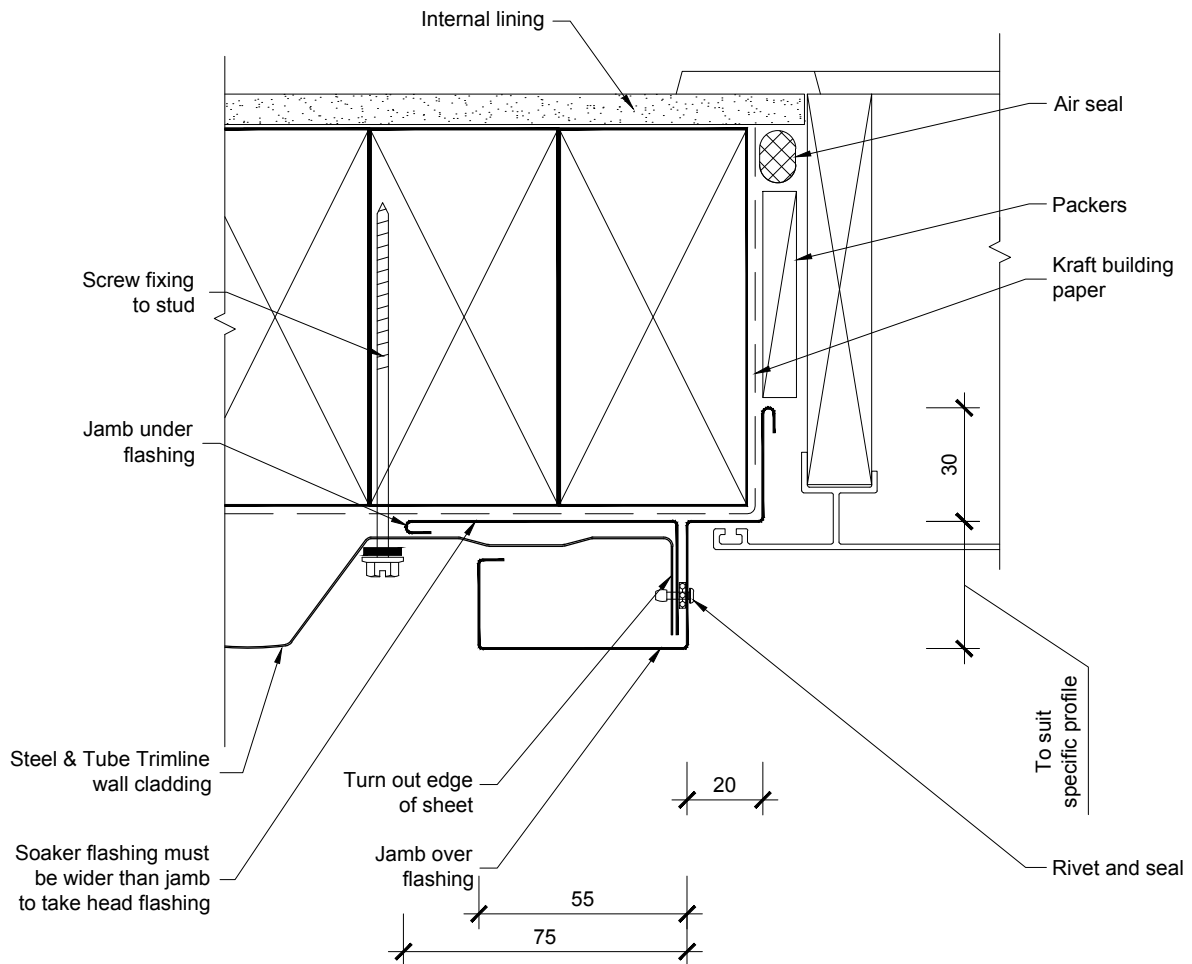

**NOTES:**

1. Window profile to be selected to achieve cover shown in details.
2. Architraves are shown for consistency only, detail may be used with rebated liner.

vrib\_trimline-wind\_alum\_rece\_jamb

**Recessed Windows for Vertical Rib Profile - Direct Fixed  
Jamb Cross Section**

All dimensions in millimetres  
Scale 1:2  
16/01/12

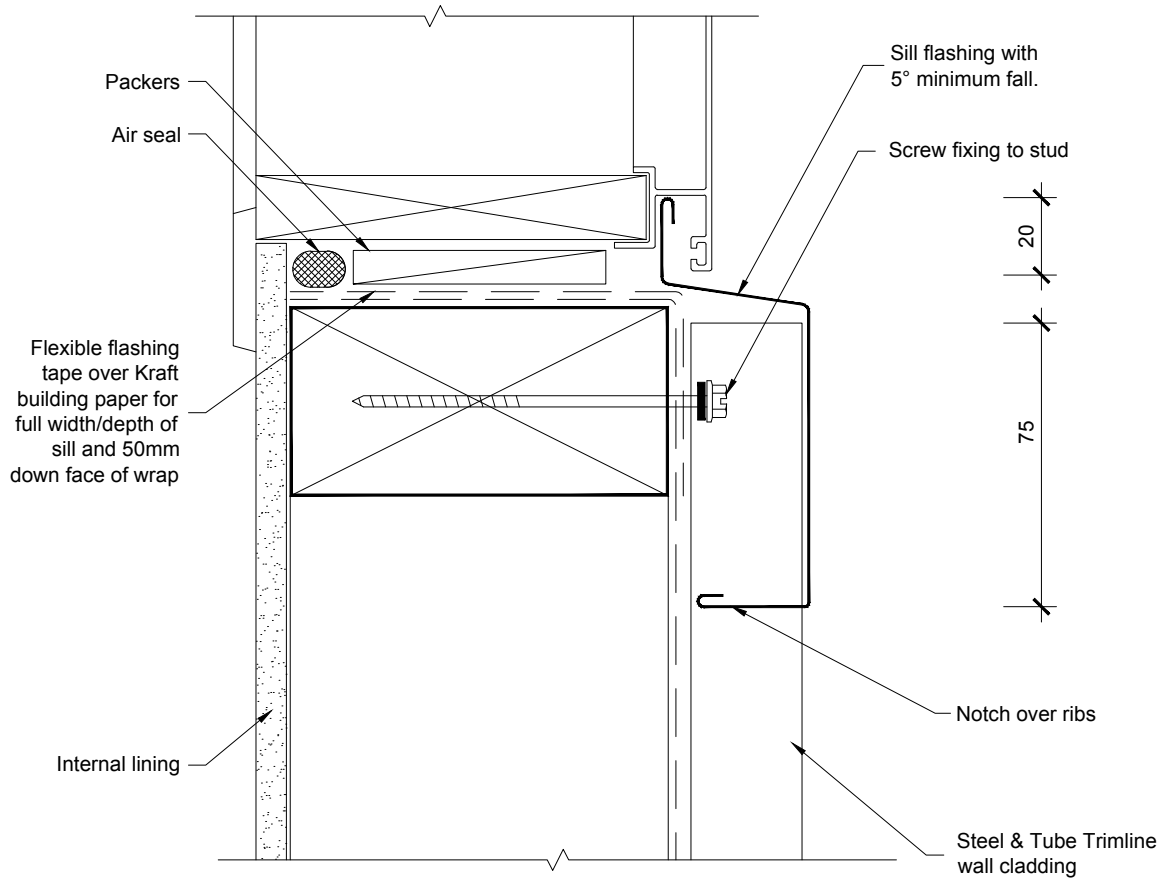

**NOTES:**

- 1: Window profile to be selected to achieve cover shown in details.
- 2: Architraves are shown for consistency only, detail may be used with rebated liner.
- 3: Make allowance between packer at sills for support brackets for large windows. Sash support brackets require specific design, and shall be supplied by the window manufacturer.

vrib\_trimline-wind\_alum\_rece\_sill

**Recessed Windows for Vertical Rib Profile - Direct Fixed**  
Sill Cross Section

All dimensions in millimetres  
Scale 1:2  
16/01/12