

STAINLESS STEEL





CONTENTS

General Information	3	Tube Bends	39
Stainless Steel Finishes	4	Hygienic Tube Reducers	42
Types Of Stainless Steel	5	Hygienic Tees and Hosetails	43
Coil And Coil Processing	7	Kleanflow™ Dairy Fittings	44
Stainless Sheet Material	8	Pipetite™	48
Plate	10	Valves	49
Round Bar	11	Perforated Sheet	53
Flat Bar	12	Stainless Steel Standard Mesh	54
Bar – Angle, Square And Channel	14	Stainless Steel Designer Mesh	55
Schedule Pipe	15	Stainless Architectural Sheet	55
Butt Weld Pipe Fittings	17	A-Justa-Foot	56
BSP Pipe Fittings	23	Handrail Tube And Fittings	57
BSP And Socket Weld Pipe Fittings	27	Fasteners, Chain & Rigging And Industrial Products	61
NPT Pipe Fittings	28	Pipe Technical Data	62
Tube And Pipe Supports	30	Technical Data > Butt Weld Fittings	63
Camlocks	31	Technical Data > BSP Threaded Class 150 Fittings	65
Flanges	32	Technical Data > NPT Dimensions Of Pipe Threads	69
Hygienic Tube	35	Flange Technical Data	70
Square And Rectangular Tube	36	Valves Technical Data	71
Spiral Welded Tube	37	Tube Bends – Properties And Dimensions	74
Seamless Tube	38		

INTRODUCTION

Steel & Tube is pleased to provide this *Stainless Steel Product Catalogue* for your use. We aim to carry all popular products and sizes on a continuous basis. The *Stainless Steel Product Catalogue* generally lists those sizes we carry ex-stock. However, there are some sizes (noted with a ♦) we offer on an indent basis only.

We also carry many products not featured in this particular publication. Please contact Steel & Tube for more information on our comprehensive range of steel products, or visit our website: www.steelandtube.co.nz

TELARC LIMITED/ISO 9001

Steel & Tube is committed to providing our customers with consistent and reliable service that meets their needs and promotes excellence in systems and a continuous improvement in quality. To demonstrate this commitment Steel & Tube is a Telarc registered supplier, certified to ISO 9001.

Telarc Limited (www.telarc.co.nz) is a national technical authority responsible for quality system certification through independent assessment, audit and testing of quality control procedures.

In practical terms, Telarc's role is to formally recognise all aspects of:

- quality in processing, distribution and service
- compliance with product or system specifications or standards
- technical competence of testing or inspecting
- quality of service performance and delivery

This role is to be carried out in a manner sufficient to provide consumers with confidence in the quality of products and services.



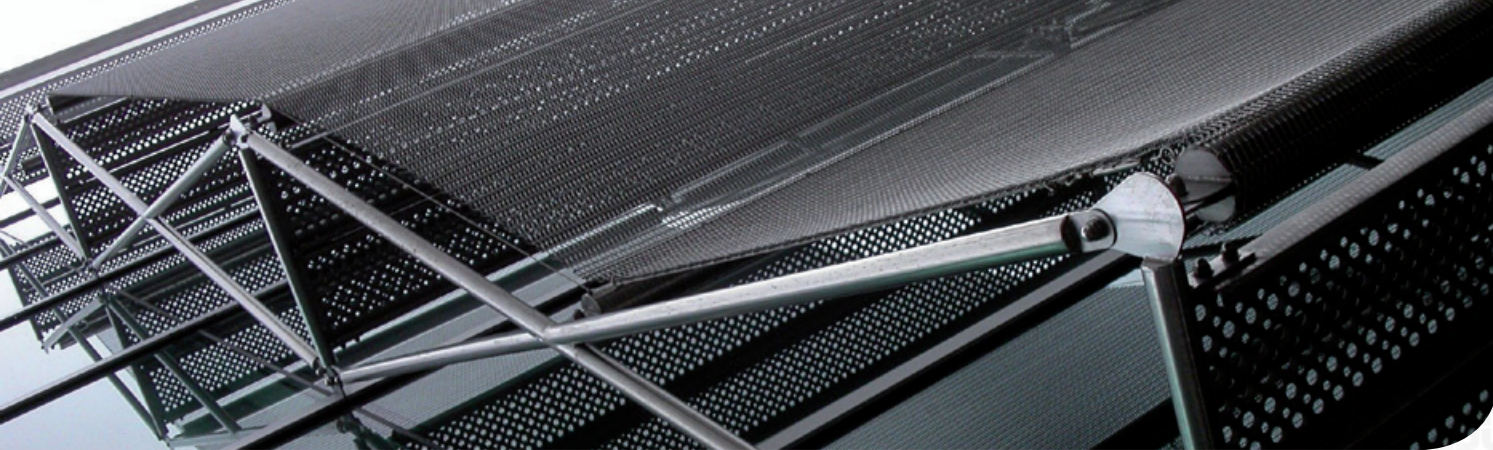

GENERAL INFORMATION

Steel & Tube is a leading distributor of stainless steel, operating from locations nationwide. We have extensive experience in providing ongoing maintenance support to major corporations, supplying large scale projects, and of course catering to the day-to-day requirements of New Zealand's stainless steel fabricators.

Major end-use industries include:

- Dairy
- Wine and beverage
- Pulp and paper
- Catering equipment
- Architectural/construction
- Meat and food processing
- Water treatment
- Petrochemical

Our extensive range includes the following products, with 304 and 316 austenitic grades available ex-stock, while other grades and products are available on an indent basis:

- Flat products, such as stainless steel coil, sheet and plate
- Bars in round, square, flat, angle and channel
- Square and rectangular tube
- Schedule pipe and fittings
- Hygienic tube and fittings
- Architectural balustrades and fittings
- Mesh and perforated sheet
- Pipe and tube valves
- Coloured, patterned and textured architectural stainless steel sheet
- Fasteners
- Tig stainless steel welding wires
- Protective films
- Food grade lubricants
- Anti-galling compounds

We also stock a comprehensive range of sundry items.

STAINLESS STEEL FINISHES

Common finishes held in stock are No.1, 2B, BA, No.4, however other finishes can be sourced.

FINISHES

No.1

Hot-rolled, annealed and pickled. Generally used where smoothness of finish is not a design consideration.

2D

A cold-rolled finish obtained from a final annealing and pickling, or a final light cold-roll pass on dull rollers, which may be polished after fabrication.

2B

A bright, moderately reflective cold-rolled finish with the annealed and de-scaled coil receiving a final light roll pass through polished rolls. This is the general purpose cold-rolled finish that can be used as is, or as a preliminary step to polishing. 2B is the most commonly used surface finish in the food and beverage sector.

BA (Bright Annealed) A mirror-like appearance, it is produced by cold-rolling, then annealing in a controlled atmosphere furnace. Grinding of the surface is then undertaken while the product is at an intermediate gauge, before the product is given a light skin pass through a cold mill over highly polished rolls. The bright finish is often used for architectural applications or uses including appliance trim, cookware, benches and food processing equipment.

No.4

A 'brushed' or 'satin' finish obtained from mechanical polishing with 120-240 grit. Used in dairy and kitchen equipment. Meets international 3A Hygiene Standards.

No.8

A mirror finish for high reflectiveness. Can be used as mirrors or reflectors.

HL (Hairline)

A finish obtained by mechanical polishing with 120-320 grit.

CF (Cold-formed)

A smooth flat reflective finish.

BP (Buff-polished)

Mechanically polished tube using 220-240 grit.

AW (As welded)

Receives no further treatment after forming and welding.

SPECIAL NOTES

Although every endeavour has been made to have all detail contained in the catalogue correct at the time of printing, we suggest product specification be confirmed with your Steel & Tube representative when placing orders.

For an up-to-date version of this catalogue please refer to our website. Items identified in this catalogue as 'stocked items' are defined as goods normally held in stock, and are subject to prior sales.

Steel & Tube terms of trade are supplied at the time of opening a trading account and are available upon request. A copy of this appears on the reverse of all invoices issued. A minimum order charge may apply.

All weights and dimensions provided in this catalogue are theoretical.

Mill tolerances will affect actual weights (+/-). All weights in this catalogue are based on a density of stainless steel being 8000kgs/m³.



TYPES OF STAINLESS STEEL

Stainless Steel is a name given to a group of steel alloys that contain more than 10.5% Chromium. Chromium has a high affinity for oxygen and forms a stable oxide film on the surface of stainless steel.

The film is called the "passive oxide layer" and forms instantaneously in ordinary atmospheres. The film is self-healing and rebuilds when it has been removed. It is this film that gives stainless steel its corrosion resistance.

AUSTENITIC GRADES

When nickel (Ni) is added to stainless steel in sufficient quantities the crystal structure is changed from ferrite to austenite, hence the term austenitic stainless steel. The basic composition of austenitic stainless steel is 18% chromium (Cr) and 8% nickel (Ni). This is called 304 grade, sometimes referred to as 18/8 or 18/10. If additional corrosion resistance is required 2% molybdenum (Mo) is added to form grade 316.

DESCRIPTIONS AND GENERAL USES

303 (INDENT ONLY)

Especially developed for machining - especially where it involves extensive machining in automatic screw machines. Sulphur or selenium is added to give excellent free machining and non-seizing properties. As sulphur or selenium is added corrosion resistance is lower than T304. T303 is not recommended for welding. Non-magnetic when annealed but becomes slightly magnetic when cold-worked.

304

The most widely used stainless steel with the best all round performance. Its carbon content is lower and its corrosion resistance after welding is higher than T302. It is less susceptible to intergranular corrosion after welding. Non-magnetic but slightly magnetic when cold worked.

304L

A low carbon stainless steel with general corrosion resistance like T304, but with superior resistance to intergranular corrosion following welding or stress relieving. Highly recommended for parts which are fabricated by welding and which can not be annealed. Generally limited to temperatures up to 426°C. The physical properties and thermal treatments of T304L are similar but not identical to T304. Non-magnetic when annealed but slightly magnetic when cold-worked.

316

Also known as marine grade stainless steel. T316 has 2-3% molybdenum which improves corrosion resistance. T316 has superior corrosion resistance to other austenitic steels when exposed to many types of chemical corrodents as well as marine environments - T316 also has applications in the chemical, textile, and paper industries. It has better strength and creep resistance at high temperatures than T304 and greater work hardening properties. Non-magnetic but slightly magnetic when cold-worked.

316L

Has lower carbon than T316, with corrosion resistance similar to T316, but superior resistance to intergranular corrosion following welding or stress relieving. It is recommended for parts which cannot be subsequently annealed. Service temperatures up to 426°C. The physical properties and thermal treatments of type 316L are similar but not identical to type 316. Non-magnetic when annealed but slightly magnetic when cold-worked.

MARTENSITIC GRADES

This grade contains 12%-18% chromium and 0.08%-1.00% carbon. The high carbon content allows the stainless steel to respond well to heat treatment to give various mechanical strengths such as hardness. However the carbon is detrimental when welding and care must be taken.

Grades 409, 410, 420 and 431 are typical martensitic grades.

FERRITIC GRADES

These are nickel free. They have varying chromium content of 12%-22% but a lower carbon content than the martensitic grades.

The increased chromium increases corrosion resistance at elevated temperatures, however the lack of mechanical properties due to the fact that it cannot be heat-treated limits its application.

DESCRIPTIONS AND GENERAL USES

430

A corrosion and heat resisting stainless steel with superior corrosion and heat resistance compared to type 410. Type 430 is non hardenable and possesses only mild cold-working properties due to the high chromium content. Its weldability is excellent and does not require subsequent annealing. Magnetic in all conditions. Common uses include builders hardware, domestic appliances (driers, dishwashers) and automotive trim.

DUPLEX STAINLESS STEEL

Duplex stainless steels have a structure of approximately equal amounts of ferrite and austenite and therefore may be referred to as ferritic-austenitic stainless steel.

The chromium varies from 18%-28% and a nickel content of 4.5% to 8% is insufficient to develop a fully austenitic crystal structure. Most grades contain molybdenum in the 2.5%-4% range, plus a small nitrogen addition which enables both strength and pitting resistance. Common uses include applications such as heat exchanger panels and tubes, tanks and vessels where high chloride concentrations are present eg sea water cooling, desalination, food pickling plants and aggressive marine waters.

STAINING AND CORROSION OF STAINLESS FITTINGS – PREVENTION IS BETTER THAN CURE

Stainless steel is an incredibly resistant building product but it is not impervious to mild staining or even corrosion in some instances. There are several factors and agents that cause both unsightly staining and more serious metal corrosion. These include exposure to marine salt or other corrosive environments, poor design or installation, surface finish and the grade of stainless steel.

Coastal conditions may be experienced as much as 20km inland from the sea, with airborne salt finding its way onto the surface and into welds and joints of stainless fittings. This salt, as well as dirt, can cause tea staining.

Tea staining is a brown discolouration of the surface. It does not structurally affect the metal but is unsightly. Washing on a regular basis with detergent or soap reduces the chances of staining. Care should be taken with all chemical cleaners and those containing chloride, such as bleach, can potentially cause surface marking on the metal. Avoid steel wool or any carbon steel cleaning tools (such as scrapers) as these may actually cause more corrosion through reaction with the stainless steel.

The design and position of the stainless steel can also impact on its appearance. If water is allowed to pool on the surface, or dirt and dampness collect in corners and hollows the stainless steel is likely to stain. Well ventilated, free-draining installations are best.

316 grade stainless is recommended for marine or corrosive areas as it has a small percentage of molybdenum added, improving resistance to tea staining and corrosion.

304 grade is slightly less corrosion resistant and is used extensively away from the coast. Using a higher polish/grit number can reduce the deposits or contaminants in most instances. All handrails and fittings in this publication are 316 or 304 grade unless otherwise indicated.

The recommendations given here for the maintenance of stainless fittings are general guidelines only. It is better to take extra care of your stainless than to follow minimum guidelines. These suggestions are based on recommendations from the Australian Stainless Steel Development Association (ASSDA).



STAINLESS – NOT STAIN-FREE

Pollen and other airborne matter, as well as salt can create corrosion on stainless steel. Rain washing the stainless steel surface may help reduce tea staining, and should therefore be an important project design consideration. Best results are achieved by washing with soap or mild detergent and warm water followed by rinsing with clean cold water.

The frequency of cleaning required will vary depending on the environment and distance from the sea, but should be at least every three months, and more frequently as required.

IF STAINING HAS OCCURRED, CONSIDER THE FOLLOWING CLEANING OPTIONS:

Fingerprints – wash with alcohol, trichloroethylene or acetone. Rinse with water and wipe dry.

Oil and grease – wash with alcohol, trichloroethylene or acetone, followed by a detergent or soap wash, rinse with water and wipe dry.

Stains and discolouration – wash with mild abrasive detergent or soap, rub in the same direction as the visible structure or surface pattern. Rinse with water and wipe dry, or wash with weak phosphoric acid solution, rinse with ammonia solution followed by water and wipe dry.

If necessary, use a plastic abrasive pad such as Scotchbrite with soapy water for a more vigorous clean (follow the visible structure or surface pattern).

Rust stains – coat the affected area with oxalic acid solution for 15-20 minutes, water rinse and wipe dry. Use abrasives (as above) if necessary.

Paint – coat the paint with a proprietary paint solvent using a soft nylon brush, water rinse and wipe dry.

Notes:

- Do not use steel brushes or steel wool, and do not use hydrochloric acid on stainless steel.
- Always use protective equipment (rubber or latex gloves, protective eyewear etc) and work in a well ventilated area when using chemicals.

COIL AND COIL PROCESSING

SIZE		GRADE / FINISH				APPROX MTRS / KG
THICKNESS MM	WIDTH MM	304			316	
		2B	2B PE	#4 PE	2B	
0.55	1219	S55C2B*				0.19
0.70	1219	S7C2B*				0.15
0.90	1219	S9C2B*			S9C2B6*	0.11
1.20	914			S12914C4PE*		0.11
1.20	1219	S12C2B*	S12C2BPE	S12C4PE*		0.09
1.50	914			S15914C4PE*		0.09
1.50	1219	S15C2B*				0.07
1.50	1219		S15C2BPE*			0.07
1.50	1219			S15C4PE*		0.07
1.50	1219				S15C2B6*	0.07
1.50	1524		S151524C2BPE*			0.05
2.00	1219	S2C2B*	S2C2BPE*			0.05
2.00	1524		S21524C2BPE*			0.04
2.50	1219		S25C2BPE*			0.04
2.50	1524		S251524C2BPE*			0.03
3.00	1219	S3C2B*	S3C2BPE			0.03
3.00	1524		S31524C2BPE*			0.03

- The range of products shown was accurate at the time of publication, but we are continually adding to this range – please contact your local branch for further information about our products and their availability.
- Selected sizes are available in grade 304/L and 316/L.

COIL PROCESSING SERVICES

Steel & Tube have coil processing facilities with stainless steel coil stocks located in both Auckland and Christchurch, offering cut-to-length or slit-to-size stainless steel coil to meet your specific needs.

With 60 years in operation as a distributor and processor of metal products in New Zealand, Steel & Tube is well placed to cater to your stainless steel coil requirements.

Please refer to the table below for a general outline of our processing capabilities or contact one of our locations.

SERVICE OFFER	LOCATION	
	AUCKLAND	CHRISTCHURCH
CUT-TO-LENGTH		
Thickness	0.40 to 3.0mm	0.40 to 3.0mm
Max Width	1524mm	1524mm
Min Width	150mm, by enquiry	580mm, by enquiry
Max Length	4000mm, longer on application	3660mm
Min Length	150mm, by enquiry	338mm, by enquiry
PE film application	Available by enquiry	NA
Minimum order quantity	To be confirmed on enquiry	15 lineal metres – on enquiry
SLIT-TO-SIZE		
Thickness	0.40 to 3.0mm	0.40 to 3.0mm
Max Width	1524mm	1524mm
Min Slit Width	10mm	10mm
Bore	508mm	508mm
PE film application	Available by enquiry	NA
Minimum order quantity	To be confirmed on enquiry	To be confirmed on enquiry

STAINLESS SHEET MATERIAL COLD-ROLLED TO ASTM A240

SIZE			GRADE / FINISH										APPROX KG/ SHEET				
THICKNESS MM	WIDTH MM	LENGTH MM	304			316/L			430								
			2B	2B/PE	#4/PE	BA/PE	2B	2B/PE	#4/PE	2B/PE	#4/PE	2B/PE	BA/PE				
0.45	1220	2440	S452BS	S452BPES													10.72
0.55	1220	2440	S552BS*	S552BPES*	S554PES*	S55BAPES	S552BS6*							S554PES430*			13.10
0.70	1220	2440	S72BS*	S72BPES*	S74PES*	S7BAPES*	S72BS6	S72BPES6*						S74PES430*			16.67
0.90	1220	2440		S92BPES*	S94PES*	S9BAPES*	S92BPES6*	S92BPES6*						S94PES430*	S92BPES430	S9BAPES43*	21.43
1.20	914	2440			S129142444PES												21.41
1.20	914	3000			S1291434PES*												26.32
1.20	914	3048		S1291430482BPES													26.74
1.20	914	3600		S12914362BPES													31.59
1.20	1220	2440		S122BPES*	S124PES*	S12BAPES*		S122BPES6*						S124PES430*	S12BAPES43*		28.58
1.20	1220	3000			S1212234PES												35.14
1.20	1220	3048		S1212230482BPES*													35.70
1.20	1220	3600			S12122364PES*												42.16
1.20	1500	3000			S121532BPES												43.20
1.20	1500	3000		S121532BPES*	S121534PES*												43.20
1.20	1500	3600		S1215362BPES	S1215364PES												51.84
1.50	914	2440			S129142444PES*												26.76
1.50	914	3048			S1591430484PES												33.43
1.50	1220	3048		S1512230482BPES													44.62
1.50	1500	3000		S151532BPES*	S151534PES*									S151532BPES6*			54.00
1.50	1525	3048		S15152530482BPE*													55.78

* Denotes normal stock items.

Note:

- Please refer to notes on page 7.

STAINLESS SHEET MATERIAL (CONTINUED) COLD-ROLLED TO ASTM A240

SIZE			GRADE / FINISH										APPROX KG/ SHEET
THICKNESS MM	WIDTH MM	LENGTH MM	304			316/L			430				
			2B	2B/PE	#4/PE	BA/PE	2B	2B/PE	#4/PE	2B	#4/PE	BA/PE	
1.50	914	3048		S1591430482BPES	S1591430484PES								33.43
1.50	914	3600		S15914362BPES									39.48
1.50	1220	2440		S152BPES*	S154PES*	S15BAPES*		S152BPES6*	S154PES6*		S154PES430*		35.72
2.00	1220	2440		S22BPES*	S24PES*			S22BPES6*	S24PES6				47.63
2.00	1500	3000		S21532BPES*	S21534PES*			S21532BPES6*					72.00
2.00	1525	3048		S2152530482BPES*									74.37
2.50	1220	2440		S252BPES	S254PES*			S252BPES6*					59.54
2.50	1500	3000		S251532BPES*				S251532BPES6*					90.00
2.50	1525	3048		S25152530482BPES*									92.96
3.00	1220	3048		S312230482BPES									89.25
3.00	1500	3000		S31532BPES*	S31534PES*			S31532BPES6*					108.00
3.00	1525	3048		S3152530482BPES*									111.56
3.00	1220	2440		S32BPES*	S34PES*			S32BPES6*	S34PES6				71.44
3.00	1500	3000		S31532BPES									108.00
3.00	2000	4000		S3242BPES*									192.00

* Denotes normal stock items.

Notes:

- Other sizes also available upon request.
- Finishes: 2B = cold-rolled, softened and descaled; BA = Bright Annealed; No.4 = Polished 120 - 240 grit; other finishes also available upon request.
- 304L available upon request.
- Weights are based on a density of 8000 kg/m³.

PLATE

STAINLESS PLATE HRAP (HOT-ROLLED ANNEALED & PICKLED) MATERIAL TO ASTM A240

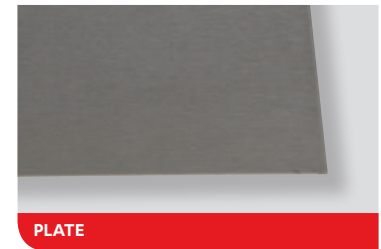

PLATE

SIZE			GRADE / FINISH				APPROX KG/SHEET
THICKNESS MM	WIDTH MM	LENGTH MM	304/L		316/L		
			NO. 1	2B	NO. 1	2B	
4.00	1500	3000		S31542BP*	S3154N1P6*	S31542BP6*	144.00
4.00	1220	2440		S42BP*			95.26
5.00	1500	3000	S3155N1P*	S31552BP*	S3155N1P6*	S31552BP6*	180.00
5.00	1220	2440		S52BP*			119.07
5.00	1500	6000		S61552BP			360.00
6.00	1220	2440		S62BP*			142.89
6.00	1500	3000	S3156N1P*	S31562BP*	S3156N1P6*	S31562BP6*	216.00
6.00	1500	6000		S61562BP			432.00
8.00	1500	3000	S3158N1P*		S3158N1P6*		288.00
10.00	1500	3000	S31510N1P*		S31510N1P6*		360.00
12.00	1500	3000	S31512N1P*		S31512N1P6*		432.00
16.00	1500	3000	S31516N1P*		S31516N1P6		576.00
20.00	1500	3000	S31520N1P		S31520N1P6		720.00
25.00	1500	3000	S31525N1P		S31525N1P6		900.00
30.00	1500	3000	AVAILABLE UPON REQUEST				
32.00	1500	3000					
40.00	1500	3000					
50.00	1500	3000					

* Denotes normal stock items.

Notes:

- Other sizes also available upon request – up to 2m wide (2B) and 2.4m wide (No. 1) by 9m length. Other grades (including duplex) also available upon request.
- Finishes: 2B = cold-rolled, softened and descaled; No.1 = hot-rolled, annealed and pickled - HRAP.

STAINLESS CHEQUER PLATE HRAP

SIZE			GRADE	APPROX KG/SHEET
THICKNESS MM	WIDTH MM	LENGTH MM	304/L	
3.50	1220	2440	S35FP*	83.35
3.50	1220	6000	S122635FP	204.96
4.50	1220	2440	S45FP*	107.16
4.50	1524	3048	S3048152445FP*	167.50
5.00	1220	2440	AVAILABLE UPON REQUEST	

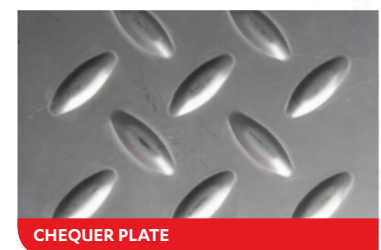

CHEQUER PLATE

* Denotes normal stock items.

Notes:

- Available in 316 upon request.
- Finishes: No.1 = hot-rolled, annealed and pickled, not cold-worked and pressed.

ROUND BAR

STAINLESS ROUND BAR MATERIAL TO A276



ROUND BAR

SIZE		GRADE		TOLER- ANCE	APPROX KG/M
DIAMETER MM	DIAMETER (INCH)	304	316		
3.18	1/8"	S18R*		H9	0.06
4.00		SM4R*		H9	0.10
4.76	3/16"	S316R*	S316R6	H9	0.14
5.00		SM5R*	SM5R6*	H9	0.16
6.00		SM6R*	SM6R6*	H9	0.23
6.35	1/4"	S14R*	S14R6*	H9	0.25
7.92	5/16"	S516R*	S516R6*	H9	0.39
8.00		SM8R*	SM8R6*	H9	0.40
9.00			SM9R6	H9	0.51
9.53	3/8"	S38R*	S38R6*	H9	0.57
10.00		SM10R*	SM10R6*	H9	0.63
11.10	7/16"	S716R	S716R6*	H9	0.77
12.00		SM12R*	SM12R6*	H9	0.90
12.70	1/2"	S12R*	S12R6*	H9	1.01
14.27	9/16"		S916R6*	H9	1.28
15.00			SM15R6	H9	1.41
15.88	5/8"	S58R*	S58R6*	H9	1.58
16.00		SM16R*	SM16R6*	H9	1.61
18.00		SM18R*	SM18R6*	H9	2.03
19.05	3/4"	S34R*	S34R6*	H9	2.28
20.00		SM20R*	SM20R6*	H9	2.51
22.23	7/8"	S78R	S78R6*	H9	3.10
25.00		SM25R*	SM25R6*	H9	3.93
25.40	1"	S1R*	S1R6*	H9	4.05
28.58	1 1/8"	S118R	S118R6*	H9	5.13
30.00		SM30R*		H9	5.65
31.75	1 1/4"	S114R*	S114R6*	H9	6.33
34.93	1 3/8"		S138R6	H9	7.66
38.10	1 1/2"	S112R*	S112R6*	H9	7.66
40.00		SM40R*	SM40R6*	H9	9.12
41.28	1 5/8"		S158R6	H9	10.70
44.45	1 3/4"	S134R	S134R6*	H9	12.41
45.00		SM45R*		H9	12.72
50.00		SM50R*	SM50R6*	H9	15.70
50.80	2"	S2R*	S2R6*	H9	16.21
57.15	2 1/4"	S214R	S214R6	H9	20.51
60.00		SM60R*	SM60R6*	H9	22.61
63.50	2 1/2"	S212R*	S212R6*	H9	25.32
65.00		SM65R*		H9	26.53

* Denotes normal stock items.

Note:

- Due to availability some diameters > 55mm may be stocked to a 'H' or 'K' tolerance.

SIZE		GRADE		TOLER- ANCE	APPROX KG/M
DIAMETER MM	DIAMETER (INCH)	304	316		
70.00		SM70R*	SM70R6*	H9	30.77
75.00		SM75R*		H9	35.33
76.20	3"	S3R*	S3R6*	H9	36.46
80.00		SM80R*	SM80R6*	H9	40.19
85.00		SM85R		H9	45.37
88.90	3 1/2"	S312R*	S312R6	H9	49.63
90.00		SM90R*	SM90R6*	K12	50.87
100.00		SM100R*	SM100R6*	K12	62.80
101.60	4"	S4R	S4R6	K12	64.83
114.30	4 1/2"	S412R		K12	82.04
120.00		SM120R*	SM120R6*	K12	90.43
125.00		SM125R*	SM125R6	K12	98.13
130.00		SM130R	SM130R6	K12	106.13
140.00		SM140R		K12	123.09
150.00		SM150R*	SM150R6*	K12	141.30
152.00	6"	S6R	S6R6	K12	145.86
170.00		SM170R	SM170R6*	K12	181.49
200.00			SM200R6	K12	251.20
203.20	8"		S8R6	K12	259.30

DIAMETER TOLERANCE OF STAINLESS ROUND BAR

DIAMETER MM	H9	H11
< 3mm	+0, -0.025	+0, -0.060
3 - 6mm	+0, -0.030	+0, -0.075
>6 - 10mm	+0, -0.036	+0, -0.090
>10 - 18mm	+0, -0.043	+0, -0.110
>18mm - 30mm	+0, -0.052	+0, -0.130
>30 - 50mm	+0, -0.062	+0, -0.160
>50 - 80mm	+0, -0.074	+0, -0.190
>80 - 120mm	+0, -0.087	+0, -0.220

Notes:

- Other sizes, grades and finishes available upon request.
- Length: Standard lengths 4 metres.
- Finishes:
 - Diameter 25mm (1") and under – ASTM A276, cold-drawn/polished.
 - Diameter greater than 25mm (1") – ASTM A276, smooth-turned, improved machining abilities.
- Minimum cut lengths and cutting charges may apply.

FLAT BAR

STAINLESS FLAT BAR

MATERIAL TO ASTM A276



FLAT BAR

WIDTH MM	THICKNESS MM	GRADE / FINISH						APPROX KG/M
		304			316			
		SRE (#1)	POLISHED	HRAP (#1)	SRE (#1)	POLISHED	HRAP (#1)	
13	3		S133FP*					0.31
20	3	S203FS*	S203FP*					0.48
20	5	S205FS*	S205FP					0.80
20	6	S206FS*						0.96
25	3	S253FS*	S253FP*		S253FS6*		S253FH6	0.60
25	5	S255FS*	S255FP*	S255FH	S255FS6			1.00
25	6	S256FS*			S256FS6*			1.20
25	10			S2510FH*			S2510FH6	2.00
25	12			S2512FH*			S2512FH6	2.40
30	3	S303FS*						0.72
30	5	S305FS*	S305FP		S305FS6			1.20
30	6	S306FS*			S306FS6			1.44
30	10			S3010FH*			S3010FH6	2.40
40	3	S403FS*	S403FP*		S403FS6*			0.96
40	5	S405FS*	S405FP*	S405FH*	S405FS6*	S405FP6		1.60
40	6	S406FS			S406FS6*			1.92
40	10			S4010FH*			S4010FH6*	3.20
40	12			S4012FH*			S4012FH6*	3.84
50	3	S503FS*	S503FP*		S503FS6*			1.20
50	5	S505FS*	S505FP*		S505FS6*	S505FP6		2.00
50	6	S506FS*	S506FP*	S506FH*	S506FS6*	S506FP6*		2.40
50	9			S509FH*				3.60
50	10		S5010FP*	S5010FH*	S5010FS6		S5010FH6*	4.00
50	12	S5012FS		S5012FH*			S5012FH6*	4.80
50	16			S5016FH*				6.40
50	19			S5019FH				7.60
50	20			S5020FH*				8.00
50	25			S5025FH			S5025FH6	10.00
60	10			S6010FH*				4.80
65	6	S656FS*			S656FS6*		S656FH6	3.12
65	10			S6510FH*			S6510FH6*	5.20
65	12			S6512FH*			S6512FH6	6.24

* Denotes normal stock items.

Note:

- Polished (POL): cold-formed with smooth satin finish and square edges.

FLAT BAR (CONTINUED)

STAINLESS FLAT BAR

MATERIAL TO ASTM A276



FLAT BAR

WIDTH MM	THICKNESS MM	GRADE / FINISH						APPROX KG/M
		304			316			
		SRE (#1)	POLISHED	HRAP (#1)	SRE (#1)	POLISHED	HRAP (#1)	
75	5	S755FS*						3.00
75	6	S756FS*	S756FP		S756FS6*			3.60
75	9			S759FH*				5.40
75	10			S7510FH*			S7510FH6*	6.00
75	12			S7512FH*			S7512FH6*	7.20
75	15			S7515FH				9.00
75	16			S7516FH*				9.60
75	25			S7525FH*				15.00
80	10			S8010FH*				6.40
100	5	S1005FS*						4.00
100	6	S1006FS*			S1006FS6*			4.80
100	9			S1009FH*				7.20
100	10			S10010FH*			S10010FH6*	8.00
100	12			S10012FH*			S10012FH6	9.60
100	19			S10019FH				15.20
100	20			S10020FH*				16.00
100	25			S10025FH*				20.00
150	5	S1505FS						6.00
150	6	S1506FS*						7.20
150	10			S15010FH*				12.00
150	12			S15012FH				14.40
200	6	S2006FS						9.60

* Denotes normal stock items.

Notes:

- Other sizes, grades and finishes available upon request.
- Length: Standard lengths 4 metres. 6 metre lengths available on enquiry, minimum order quantities may apply. Minimum cut-lengths and cutting charges may apply.
- Finishes:
 - SRE = Slit Rolled Edge, hairline finish = between 120 - 240 grit.
 - HRAP = Hot-rolled annealed and pickled.
- Additional Services: Polishing available - lead times may apply.



BAR – ANGLE, SQUARE AND CHANNEL

STAINLESS SQUARE BAR MATERIAL TO ASTM A276

SIZE (WIDTH X THICKNESS) MM	304		316		APPROX KG/M
	HRAP	CD	HRAP	CD	
4 x 4		S45QC			0.13
5 x 5		S55QC		S55QC6	0.20
6 x 6		S65QC*		S65QC6	0.29
8 x 8		S85QC*	S85QH6	S85QC6	0.50
10 x 10		S105QC*	S105QH6	S105QC6	0.80
12 x 12		S125QC*	S125QH6	S125QC6	1.15
16 x 16	S165QH	S165QC*	S165QH6	S165QC6	2.05
20 x 20	S205QH	S205QC*	S205QH6	S205QC6	3.20
25 x 25	S255QH*	S255QC*	S255QH6		5.11
32 x 32	S325QH*	S325QC*	S325QH6		8.19
38 x 38	S385QH				11.55
40 x 40	S405QH	S405QC*			12.80
50 x 50	S505QH*	S505QC*	S505QH6		20.00



SQUARE BAR

* Denotes normal stock items.

Notes:

- Other sizes and finishes also available upon request.
- Length: Standard lengths 3 metres. Minimum cut-lengths and cutting charges may apply.
- Finishes:
 - CD = Cold-drawn.

STAINLESS ANGLE MATERIAL TO ASTM A276

SIZE (WIDTH X THICKNESS) MM	304		316	APPROX KG/M
	HRAP	CF	HRAP	
20 x 20 x 3	S203AH*		S203AH6	0.89
25 x 25 x 3	S253AH*	S253AP*	S253AH6*	1.13
25 x 25 x 5	S255AH*			1.80
25 x 25 x 6			S256AH6*	2.11
30 x 30 x 3	S303AH*	S303AP*	S303AH6	1.37
30 x 30 x 5	S305AH*		S305AH6	2.20
40 x 40 x 3	S403AH*	S403AP*	S403AH6*	1.85
40 x 40 x 5	S405AH*		S405AH6*	3.00
40 x 40 x 6	S406AH*		S406AH6*	3.55
50 x 50 x 3	S503AH*	S503AP*	S503AH6*	2.33
50 x 50 x 5	S505AH*			3.80
50 x 50 x 6	S506AH*		S506AH6*	4.51
65 x 65 x 6	S656AH*		S656AH6*	5.95
75 x 75 x 6	S756AH		S756AH6*	6.91
75 x 75 x 9	S759AH*		S759AH6*	10.15
100 x 100 x 6	S1006AH*		S1006AH6*	9.31
100 x 100 x 10	S10010AH*		S10010AH6*	15.20



ANGLE

* Denotes normal stock items.

Notes:

- Other sizes and finishes also available upon request.
- Length: Standard lengths 4 metres for CF and 6 metres for HRAP. Minimum cut-lengths and cutting charges may apply.
- Finishes:
 - CF = Cold-formed smooth bright finish/edge with radius external corner.
 - HRAP = Hot-rolled annealed and pickled.

STAINLESS CHANNEL MATERIAL TO ASTM A276

SIZE (WIDTH X THICKNESS) MM	304	316	APPROX KG/M
	HRAP	HRAP	
80 x 40 x 5	S8040C*		6.10
100 x 50 x 6	S10050C*	S10050C6*	9.15
150 x 75 x 6	S15075C*		14.10



CHANNEL

* Denotes normal stock items.

Notes:

- Other sizes and finishes also available upon request.
- Length: Standard lengths 6 metres. Minimum cut-lengths and cutting charges may apply.
- Finishes: HRAP = Hot-rolled annealed and pickled.

SCHEDULE PIPE

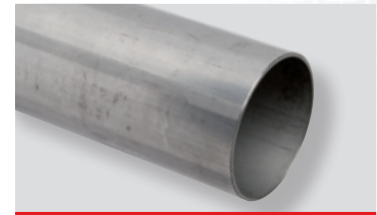

STAINLESS SCHEDULE 10 PIPE

STAINLESS SCHEDULE 10S PIPE MATERIAL TO ASTM A312

SIZE (NOMINAL BORE)		OUTSIDE DIAMETER MM	WALL THICKNESS MM	WELDED		APPROX KGS/M
MM	INCH			304L	316L	
10	3/8"	17.15	1.65		S10S10WP6	0.85
15	1/2"	21.34	2.11	S15S10WP*	S15S10WP6*	1.01
20	3/4"	26.67	2.11	S20S10WP*	S20S10WP6*	1.28
25	1"	33.4	2.77	S25S10WP*	S25S10WP6*	2.09
32	1 1/4"	42.16	2.77	S32S10WP*	S32S10WP6	2.69
40	1 1/2"	48.26	2.77	S40S10WP*	S40S10WP6*	3.11
50	2"	60.03	2.77	S50S10WP*	S50S10WP6*	3.93
65	2 1/2"	73.03	3.05	S65S10WP*	S65S10WP6*	5.26
80	3"	88.9	3.05	S80S10WP*	S80S10WP6*	6.45
90	3 1/2"	101.6	3.05		S90S10WP6*	7.4
100	4"	114.3	3.05	S100S10WP*	S100S10WP6*	8.36
125	5"	141.3	3.4		S125S10WP6*	11.57
150	6"	168.28	3.4	S150S10WP*	S150S10WP6*	13.86
200	8"	219.18	3.76	S200S10WP*	S200S10WP6*	20
250	10"	273.05	4.19	S250S10WP*	S250S10WP6*	27.8
300	12"	323.85	4.57	S300S10WP	S300S10WP6*	36.3
350	14"	355.6	4.78		S350S10WP6*	41.8
400	16"	406.4	4.78	S400S10WP	S400S10WP6*	47.8
450	18"	457.2	4.78		S450S10WP6*	53.9
500	20"	508	5.54		S500S10WP6*	69.3
600	24"	609.6	6.35			95.4
750	30"	762	7.92		S750S10WP6	148.8

* Denotes normal stock items.

Notes:

- Other sizes available upon request.
- Please refer to Pipe Technical Data on page 62 for theoretical bursting pressures (kPa) of schedule pipe.

SCHEDULE PIPE (CONTINUED)



STAINLESS SCHEDULE 40 PIPE

STAINLESS SCHEDULE 40 PIPE MATERIAL TO ASTM A312

SIZE (NOMINAL BORE)		OUTSIDE DIAMETER MM	WALL THICKNESS MM	WELDED		SEAMLESS	APPROX KGS/M
MM	INCH			304L	316L	316L	
6	1/8"	10.29	1.73		S6WP6*	S6SP6	0.37
8	1/4"	13.72	2.24	S8WP*	S8WP6*	S8SP6	0.63
10	3/8"	17.15	2.31		S10WP6*	S10SP6	0.85
15	1/2"	21.34	2.77	S15WP*	S15WP6*	S15SP6	1.27
20	3/4"	26.67	2.87	S20WP*	S20WP6*	S20SP6*	1.69
25	1"	33.40	3.38	S25WP*	S25WP6*	S25SP6*	2.50
32	1 1/4"	42.16	3.56	S32WP*	S32WP6*		3.39
40	1 1/2"	48.26	3.68	S40WP*	S40WP6*	S40SP6*	4.05
50	2"	60.33	3.91	S50WP*	S50WP6*	S50SP6*	5.44
65	2 1/2"	73.03	5.16	S65WP*	S65WP6*	S65SP6	8.63
80	3"	88.90	5.49	S80WP*	S80WP6*	S80SP6*	11.29
90	3 1/2"	101.60	5.74		S90WP6*		13.60
100	4"	114.30	6.02	S100WP*	S100WP6*	S100SP6*	16.07
125	5"	141.30	6.55		S125WP6*		21.80
150	6"	168.28	7.11	S150WP*	S150WP6*	S150SP6	28.30
200	8"	219.08	8.18	S200WP*	S200WP6*		42.50
250	10"	273.05	9.27		S250WP6*		60.30
300	12"	323.85	9.52		S300WP6*		73.88

STAINLESS SCHEDULE 80 PIPE MATERIAL TO ASTM A312

SIZE (NOMINAL BORE)		OUTSIDE DIAMETER MM	WALL THICKNESS MM	SEAMLESS	APPROX KGS/M
MM	INCH			316L	
8	1/4"	13.72	3.02	S8S80SP6*	0.80
10	3/8"	17.15	3.20	S10S80SP6	1.10
15	1/2"	21.34	3.73	S15S80SP6*	1.62
20	3/4"	26.67	3.91	S20S80SP6*	2.19
25	1"	33.40	4.55	S25S80SP6*	3.24
32	1 1/4"	42.16	4.85	S32S80SP6	4.47
40	1 1/2"	48.26	5.08	S40S80SP6*	5.41
50	2"	60.33	5.54	S50S80SP6*	7.48
65	2 1/2"	73.03	7.01	S65S80SP6*	11.41
80	3"	88.90	7.62	S80S80SP6*	15.27
100	4"	114.30	8.56	S100S80SP6*	22.32
125	5"	141.30	9.52	S125S80SP6	30.90
150	6"	168.28	10.97	S150S80SP6	42.60
200	8"	219.08	12.70	S200S80SP6	64.60



STAINLESS SCHEDULE 80 PIPE

Notes:

- Other sizes also available upon request.
- Schedule 160 316L seamless available upon request.
- Please refer to Pipe Technical Data on page 62 for theoretical bursting pressures (kPa) of schedule pipe.

* Denotes normal stock items.

BUTT WELD PIPE FITTINGS



90 DEGREES LONG RADIUS



90 DEGREES SHORT RADIUS



45 DEGREE ELBOW

STAINLESS SCHEDULE 10 AND 40 BUTT WELD ELBOW TO ASTM A403

SIZE (NOMINAL BORE)		90° LONG RADIUS ELBOW				90° SHORT RADIUS ELBOW		45° ELBOW	
MM	INCH	304L S10	316L S10	304L S40	316L S40	316L S10	316L S40	316L S10	316L S40
15	1/2"	S15S10WE*	S15S10WE6*	S15WE*	S15WE6*			S15S10WE456	S15WE456*
20	3/4"	S20S10WE*	S20S10WE6*	S20WE*	S20WE6*			S20S10WE456*	S20WE456*
25	1"	S25S10WE*	S25S10WE6*	S25WE*	S25WE6*	S25S10SWE6*	S25SWE6*	S25S10WE456	S25WE456*
32	1 1/4"	S32S10WE*	S32S10WE6*	S32WE*	S32WE6*	S32S10SWE6*	S32SWE6*	S32S10WE456*	S32WE456*
40	1 1/2"	S40S10WE*	S40S10WE6*	S40WE*	S40WE6*	S40S10SWE6*	S40SWE6*	S40S10WE456*	S40WE456*
50	2"	S50S10WE*	S50S10WE6*	S50WE*	S50WE6*	S50S10SWE6*	S50SWE6*	S50S10WE456*	S50WE456*
65	2 1/2"	S65S10WE*	S65S10WE6*	S65WE*	S65WE6*	S65S10SWE6*	S65SWE6*	S65S10WE456*	S65WE456*
80	3"	S80S10WE*	S80S10WE6*	S80WE*	S80WE6*	S80S10SWE6*	S80SWE6	S80S10WE456*	S80WE456*
90	3 1/2"		S90S10WE6	S90WE	S90WE6*				
100	4"	S100S10WE*	S100S10WE6*	S100WE*	S100WE6*	S100S10SWE6*	S100SWE6	S100S10WE456*	S100WE456
125	5"		S125S10WE6*		S125WE6*	S125S10SWE6*			
150	6"	S150S10WE*	S150S10WE6*	S150WE*	S150WE6	S150S10SWE6*	S150SWE6	S150S10WE456*	S150WE456*
200	8"	S200S10WE*	S200S10WE6*	S200WE*	S200WE6*	S200S10SWE6	S200SWE6	S200S10WE456*	
250	10"	S250S10WE*	S250S10WE6*		S250WE6*	S250S10SWE6		S250S10WE456*	
300	12"	S300S10WE	S300S10WE6*		S300WE6	S300S10SWE6*		S300S10WE456*	
350	14"		S350S10WE6			S350S10SWE6			
400	16"		S400S10WE6			S400S10SWE6		S400S10WE456	
450	18"		S450S10WE6						
500	20"		S500S10WE6			S500S10SWE6			
600	24"		S600S10WE6			S600S10SWE6		S600S10WE456	

* Denotes normal stock items.

Note:

- Other sizes and grades also available upon request including seamless.

BUTT WELD PIPE FITTINGS (CONTINUED)

STAINLESS SCHEDULE 10 AND 40 BUTT WELD EQUAL TEE TO ASTM A403

SIZE (NOMINAL BORE)		SCHEDULE 10		SCHEDULE 40
MM	INCH	304L	316L	316L
15	1/2"	S15S10WT		S15WT6*
20	3/4"	S20S10WT*	S20S10WT6*	S20WT6*
25	1"	S25S10WT*	S25S10WT6*	S25WT6*
32	1 1/4"	S32S10WT	S32S10WT6*	S32WT6*
40	1 1/2"	S40S10WT*	S40S10WT6*	S40WT6*
50	2"	S50S10WT*	S50S10WT6*	S50WT6*
65	2 1/2"	S65S10WT*	S65S10WT6*	S65WT6*
80	3"	S80S10WT*	S80S10WT6*	S80WT6*
90	3 1/2"			
100	4"	S100S10WT*	S100S10WT6*	S100WT6*
125	5"			
150	6"	S150S10WT*	S150S10WT6*	S150WT6*
200	8"	S200S10WT*	S200S10WT6*	
250	10"		S250S10WT6*	
300	12"		S300S10WT6	
350	14"		S350S10WT6	
400	16"	S400S10WT	S400S10WT6	
450	18"	S450S10WT	S450S10WT6	
500	20"		S500S10WT6	
600	24"			



* Denotes normal stock items.

Note:

- Other sizes and grades also available upon request including seamless.

BUTT WELD PIPE FITTINGS (CONTINUED)

STAINLESS SCHEDULE 10 AND 40 BUTT WELD REDUCING TEE TO ASTM A403

NOMINAL PIPE SIZE MM	SCH 10 316L	SCH 40 316L
20 x 15	S2015S10WT6*	
25 x 15	S2515S10WT6*	
25 x 20	S2520S10WT6	
32 x 15	S3215S10WT6	
32 x 20	S3220S10WT6*	
32 x 25	S3225S10WT6	
40 x 15	S4015S10WT6	
40 x 20	S4020S10WT6*	S4020WT6
40 x 25	S4025S10WT6*	S4025WT6
40 x 32	S4032S10WT6	
50 x 20	S5020S10WT6	
50 x 25	S5025S10WT6*	S5025WT6*
50 x 32	S5032S10WT6	
50 x 40	S5040S10WT6*	
65 x 40	S6540S10WT6	
65 x 50	S6550S10WT6*	
80 x 25	S8025S10WT6*	
80 x 40	S8040S10WT6	
80 x 50	S8050S10WT6*	S8050WT6
80 x 65	S8065S10WT6*	S8065WT6*
100 x 40		S10040WT6*
100 x 50	S10050S10WT6*	S10050WT6
100 x 65	S10065S10WT6	
100 x 80	S10080S10WT6*	S10080WT6
150 x 80	S15080S10WT6	S15080WT6*
150 x 100	S150100S10WT6*	S150100WT6
200 x 100	S200100S10WT6	
200 x 150	S200150S10WT6	



REDUCING TEE

* Denotes normal stock items.

Note:

- Other sizes and grades also available upon request including seamless.

BUTT WELD PIPE FITTINGS (CONTINUED)

STAINLESS SCHEDULE 10 AND 40 BUTT WELD CONCENTRIC REDUCER TO ASTM A403

NOMINAL PIPE SIZE MM	SCH 10 316L	SCH 40 316L
20 x 15	S2015S10WCR6*	S2015WCR6*
25 x 15	S2515S10WCR6*	S2515WCR6*
25 x 20	S2520S10WCR6*	S2520WCR6*
32 x 15		
32 x 20	S3220S10WCR6*	S3220WCR6*
32 x 25	S3225S10WCR6*	S3225WCR6*
40 x 15		
40 x 20	S4020S10WCR6*	S4020WCR6*
40 x 25	S4025S10WCR6*	S4025WCR6*
40 x 32	S4032S10WCR6*	S4032WCR6*
50 x 15	S5015S10WCR6	S5015WCR6
50 x 20	S5020S10WCR6*	S5020WCR6*
50 x 25	S5025S10WCR6*	S5025WCR6*
50 x 32	S5032S10WCR6	S5032WCR6*
50 x 40	S5040S10WCR6*	S5040WCR6*
65 x 25	S6525S10WCR6	S6525WCR6
65 x 32	S6532S10WCR6	
65 x 40	S6540S10WCR6*	S6540WCR6*
65 x 50	S6550S10WCR6*	S6550WCR6*
80 x 25	S8025S10WCR6*	S8025WCR6*
80 x 40	S8040S10WCR6*	S8040WCR6*
80 x 50	S8050S10WCR6*	S8050WCR6*
80 x 65	S8065S10WCR6*	S8065WCR6*
100 x 40	S10040S10WCR6	
100 x 50	S10050S10WCR6*	S10050WCR6*
100 x 65	S10065S10WCR6*	S10065WCR6*
100 x 80	S10080S10WCR6*	S10080WCR6*
125 x 80		
125 x 100	S125100S10WCR6	
150 x 80	S15080S10WCR6*	S15080WCR6*
150 x 100	S150100S10WCR6*	S150100WCR6*
150 x 125	S150125S10WCR6	S150125WCR6
200 x 100	S200100S10WCR6*	
200 x 125	S200125S10WCR6*	
200 x 150	S200150S10WCR6*	S200150WCR6
250 x 100	S250100S10WCR6	
250 x 150	S250150S10WCR6*	
250 x 200	S250200S10WCR6*	S250200WCR6
300 x 150	S350150S10WCR6*	
300 x 200	S300200S10WCR6*	
300 x 250	S300250S10WCR6	
350 x 150		
350 x 200	S350200S10WCR6	
350 x 250	S350250S10WCR6	
350 x 300	S350300S10WCR6	
400 x 250	S400250S10WCR6	
400 x 300	S400300S10WCR6	
450 x 400		



CONCENTRIC REDUCER

* Denotes normal stock items.

Note:

- Other sizes and grades also available upon request.

BUTT WELD PIPE FITTINGS (CONTINUED)

STAINLESS SCHEDULE 10 AND 40 BUTT WELD ECCENTRIC REDUCER TO ASTM A403

NOMINAL PIPE SIZE MM	SCH 10 316L	SCH 40 316L
20 x 15		S2015WER6
25 x 15	S2515S10WER6*	
25 x 20		
32 x 15	S3215S10WER6	
32 x 20	S3220S10WER6	
32 x 25		
40 x 15		S4015WER6
40 x 20	S4020S10WER6	S4020WER6*
40 x 25		S4025WER6*
40 x 32		
50 x 15		
50 x 20	S5020S10WER6	
50 x 25	S5025S10WER6*	S5025WER6*
50 x 32		
50 x 40	S5040S10WER6*	S5040WER6*
65 x 25		
65 x 32		
65 x 40		S6540WER6
65 x 50	S6550S10WER6	
80 x 25		
80 x 40	S8040S10WER6*	S8040WER6
80 x 50	S8050S10WER6	S8050WER6*
80 x 65	S8065S10WER6*	S8065WER6
100 x 40		
100 x 50	S10050S10WER6*	
100 x 65		
100 x 80	S10080S10WER6	S10080WER6*
125 x 80		
125 x 100		
150 x 80	S15080S10WER6	S15080WER6
150 x 100	S150100S10WER6	S150100WER6
150 x 125		
200 x 100	S200100S10WER6*	
200 x 125		
200 x 150	S200150S10WER6*	S200150WER6
250 x 100	S250100S10WER6	
250 x 150		
250 x 200	S250200S10WER6	
300 x 150		
300 x 200	S300200S10WER6	
300 x 250	S300250S10WER6	
350 x 150		
400 x 300		

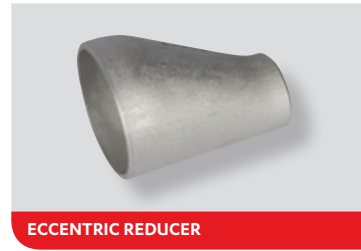

ECCENTRIC REDUCER

* Denotes normal stock items.

Note:

- Other sizes and grades also available upon request.

BUTT WELD PIPE FITTINGS (CONTINUED)

STAINLESS SCHEDULE 10 AND 40 'TYPE A' STUB END TO ASTM A403

SIZE (NOMINAL BORE)		OUTSIDE FLANGE DIAMETER MM	SCH 10 316L	SCH 40 316L
MM	INCH			
25	1"	50.8	S25S10WSE6*	S25WSE6*
32	1 1/4"	63.5	S32S10WSE6*	S32WSE6*
40	1 1/2"	73.03	S40S10WSE6*	S40WSE6
50	2"	92.08	S50S10WSE6*	S50WSE6*
65	2 1/2"	104.78	S65S10WSE6*	
80	3"	127	S80S10WSE6*	S80WSE6
100	4"	157.18	S100S10WSE6*	S100WSE6
150	6"	215.9	S150S10WSE6*	S150WSE6
200	8"	269.88	S200S10WSE6*	
250	10"	323.85	S250S10WSE6*	
300	12"	381	S300S10WSE6	



STUB END

* Denotes normal stock items.

Notes:

- Other sizes and grades also available upon request.
- The 'Type A' has its outside corner radiused to accommodate lap joint flanges. The inside corner is square.

STAINLESS SCHEDULE 10 AND 40 PIPE CAP TO ASTM A403

SIZE (NOMINAL BORE)		SCH 10 316L	SCH 40 316L
MM	INCH		
15	1/2"	S15S10WC6*	S15WC6*
20	3/4"	S20S10WC6*	S20WC6*
25	1"	S25S10WC6*	S25WC6*
32	1 1/4"	S32S10WC6*	S32WC6*
40	1 1/2"	S40S10WC6*	S40WC6*
50	2"	S50S10WC6*	S50WC6*
65	2 1/2"	S65S10WC6*	S65WC6*
80	3"	S80S10WC6*	S80WC6*
100	4"	S100S10WC6*	S100WC6*
125	5"		S125WC6*
150	6"	S150S10WC6*	S150WC6*
200	8"	S200S10WC6*	S200WC6*
250	10"	S250S10WC6*	S250WC6*
300	12"	S300S10WC6*	S300WC6
350	14"		S350WC6
400	16"	S400S10WC6	



PIPE CAP

* Denotes normal stock items.

Note:

- Other sizes and grades also available upon request.

BSP PIPE FITTINGS

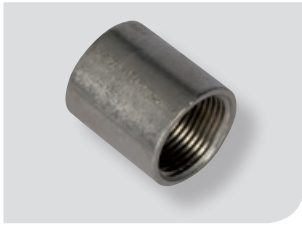

BSP THREADED PIPE SOCKET

SIZE (NOMINAL BORE)		150LB 316	3000LB 316
MM	INCH		
6	1/8"	S6BS6*	
8	1/4"	S8BS6*	S8HBS6*
10	3/8"	S10BS6*	S10HBS6*
15	1/2"	S15BS6*	S15HBS6*
20	3/4"	S20BS6*	S20HBS6*
25	1"	S25BS6*	S25HBS6*
32	1 1/4"	S32BS6*	S32HBS6*
40	1 1/2"	S40BS6*	S40HBS6
50	2"	S50BS6*	S50HBS6*
65	2 1/2"	S65BS6*	
80	3"	S80BS6*	
100	4"	S100BS6*	



BSP BARREL NIPPLE

SIZE (NOMINAL BORE)		150LB 316
MM	INCH	
6	1/8"	S6BBN6*
8	1/4"	S8BBN6*
10	3/8"	S10BBN6*
15	1/2"	S15BBN6*
20	3/4"	S20BBN6*
25	1"	S25BBN6*
32	1 1/4"	S32BBN6*
40	1 1/2"	S40BBN6*
50	2"	S50BBN6*
65	2 1/2"	S65BBN6*
80	3"	S80BBN6*
100	4"	S100BBN6*



BSP PIPE CAP

SIZE (NOMINAL BORE)		150LB 316
MM	INCH	
8	1/4"	S8BC6*
10	3/8"	S10BC6*
15	1/2"	S15BC6*
20	3/4"	S20BC6*
25	1"	S25BC6*
32	1 1/4"	S32BC6*
40	1 1/2"	S40BC6*
50	2"	S50BC6*
65	2 1/2"	S65BC6
80	3"	S80BC6
100	4"	S100BC6*



BSP PIPE CROSS

SIZE (NOMINAL BORE)		150LB 316
MM	INCH	
8	1/4"	S8BX6*
10	3/8"	S10BX6*
15	1/2"	S15BX6*
20	3/4"	S20BX6*
25	1"	S25BX6*
32	1 1/4"	S32BX6*
40	1 1/2"	S40BX6*
50	2"	S50BX6*

* Denotes normal stock items.

Note:

- Other sizes, grades and ratings also available upon request.

BSP PIPE FITTINGS (CONTINUED)



BSP WELD NIPPLE

SIZE (NOMINAL BORE)		150LB 316
MM	INCH	
6	1/8"	S6BWN6*
8	1/4"	S8BWN6*
10	3/8"	S10BWN6*
15	1/2"	S15BWN6*
20	3/4"	S20BWN6*
25	1"	S25BWN6*
32	1 1/4"	S32BWN6*
40	1 1/2"	S40BWN6*
50	2"	S50BWN6*
65	2 1/2"	S65BWN6*
80	3"	S80BWN6*
100	4"	S100BWN6*



BSP REDUCING WELD NIPPLE

SIZE (NOMINAL BORE)		150LB 316
MM	INCH	
6	1/8"	
8	1/4"	
10	3/8"	
15	1/2"	S15BRWN6*
20	3/4"	S20BRWN6*
25	1"	S25BRWN6*
32	1 1/4"	S32BRWN6*
40	1 1/2"	S40BRWN6*
50	2"	S50BRWN6*
65	2 1/2"	S65BRWN6*
80	3"	S80BRWN6*
100	4"	S100BRWN6*



BSP 45° F/F ELBOW

SIZE (NOMINAL BORE)		150LB 316
MM	INCH	
6	1/8"	
8	1/4"	S8BE456
10	3/8"	S10BE456
15	1/2"	S15BE456
20	3/4"	S20BE456
25	1"	S25BE456
32	1 1/4"	S32BE456
40	1 1/2"	S40BE456
50	2"	S50BE456
65	2 1/2"	S65BE456
80	3"	S80BE456
100	4"	



BSP HEX NIPPLE

SIZE (NOMINAL BORE)		150LB 316	3000LB 316
MM	INCH		
6	1/8"	S6BHN6*	
8	1/4"	S8BHN6*	S8HBHN6*
10	3/8"	S10BHN6*	
15	1/2"	S15BHN6*	S15HBHN6*
20	3/4"	S20BHN6*	S20HBHN6*
25	1"	S25BHN6*	S25HBHN6*
32	1 1/4"	S32BHN6*	S32HBHN6*
40	1 1/2"	S40BHN6*	S40HBHN6*
50	2"	S50BHN6*	S50HBHN6*
65	2 1/2"	S65BHN6*	
80	3"	S80BHN6*	
100	4"	S100BHN6*	



BSP 90° F/F ELBOW

SIZE (NOMINAL BORE)		150LB 316L	3000LB 316L
MM	INCH		
6	1/8"	S6BE6*	
8	1/4"	S8BE6*	S8HBE6*
10	3/8"	S10BE6*	
15	1/2"	S15BE6*	S15HBE6
20	3/4"	S20BE6*	S20HBE6*
25	1"	S25BE6*	S25HBE6*
32	1 1/4"	S32BE6*	
40	1 1/2"	S40BE6*	S40HBE6*
50	2"	S50BE6*	S50HBE6*
65	2 1/2"	S65BE6*	
80	3"	S80BE6	
100	4"	S100BE6*	

* Denotes normal stock items.

Note:

- Other sizes, grades and ratings also available upon request.

BSP PIPE FITTINGS (CONTINUED)



BSP 90° M/F ELBOW

SIZE (NOMINAL BORE)		150LB 316
MM	INCH	
6	1/8"	S6BMFE6*
8	1/4"	S8BMFE6*
10	3/8"	S10BMFE6*
15	1/2"	S15BMFE6*
20	3/4"	S20BMFE6*
25	1"	S25BMFE6*
32	1 1/4"	S32BMFE6*
40	1 1/2"	S40BMFE6*
50	2"	S50BMFE6*
65	2 1/2"	S65BMFE6*
80	3"	S80BMFE6*
100	4"	



BSP HOSE TAIL

SIZE (NOMINAL BORE)		150LB 316
MM	INCH	
6	1/8"	
8	1/4"	S8BHT6*
10	3/8"	S10BHT6*
15	1/2"	S15BHT6*
20	3/4"	S20BHT6*
25	1"	S25BHT6*
32	1 1/4"	S32BHT6*
40	1 1/2"	S40BHT6*
50	2"	S50BHT6*
65	2 1/2"	S65BHT6*
80	3"	S80BHT6*
100	4"	S100BHT6*



BSP BACK NUT

SIZE (NOMINAL BORE)		150LB 316
MM	INCH	
6	1/8"	S6BLN6*
8	1/4"	S8BLN6*
10	3/8"	S10BLN6*
15	1/2"	S15BLN6*
20	3/4"	S20BLN6*
25	1"	S25BLN6*
32	1 1/4"	S32BLN6*
40	1 1/2"	S40BLN6*
50	2"	S50BLN6*
65	2 1/2"	S65BLN6*
80	3"	
100	4"	



BSP TEE

SIZE (NOMINAL BORE)		150LB 316L	3000LB 316L
MM	INCH		
6	1/8"	S6BT6*	
8	1/4"	S8BT6*	S8HBT6*
10	3/8"	S10BT6*	
15	1/2"	S15BT6*	S15HBT6*
20	3/4"	S20BT6*	S20HBT6*
25	1"	S25BT6*	S25HBT6*
32	1 1/4"	S32BT6*	S32HBT6*
40	1 1/2"	S40BT6*	S40HBT6*
50	2"	S50BT6*	
65	2 1/2"	S65BT6*	
80	3"	S80BT6*	
100	4"	S100BT6*	



BSP UNION

SIZE (NOMINAL BORE)		150LB 316L	3000LB 316L
MM	INCH		
6	1/8"	S6BU6*	
8	1/4"	S8BU6*	
10	3/8"	S10BU6*	
15	1/2"	S15BU6*	S15HBU6*
20	3/4"	S20BU6*	S20HBU6*
25	1"	S25BU6*	S25HBU6*
32	1 1/4"	S32BU6*	S32HBU6*
40	1 1/2"	S40BU6*	S40HBU6
50	2"	S50BU6*	S50HBU6*
65	2 1/2"	S65BU6*	
80	3"	S80BU6	
100	4"		

* Denotes normal stock items.

Note:

- Other sizes, grades and ratings also available upon request.

BSP PIPE FITTINGS (CONTINUED)



BSP HEX REDUCING BUSH

SIZE (NOMINAL BORE)		150LB 316L	3000LB 316L
MM	INCH		
8 x 6	1/4" x 1/8	S86BB6*	
10 x 6	3/8" x 1/8"	S106BB6*	
10 x 8	3/8" x 1/4"	S108BB6*	S108HBB6*
15 x 6	1/2" x 1/8"	S156BB6*	
15 x 8	1/2" x 1/4"	S158BB6*	S158HBB6*
15 x 10	1/2" x 3/8"	S1510BB6*	S1510HBB6
20 x 8	3/4" x 1/4"	S208BB6*	S208HBB6*
20 x 10	3/4" x 3/8"	S2010BB6*	
20 x 15	3/4" x 1/2"	S2015BB6*	S2015HBB6*
25 x 8	1" x 1/4"	S258BB6*	S258HBB6*
25 x 10	1" x 3/8"	S2510BB6*	
25 x 15	1" x 1/2"	S2515BB6*	S2515HBB6*
25 x 20	1" x 3/4"	S2520BB6*	S2520HBB6*
32 x 15	1 1/4" x 1/2"	S3215BB6*	
32 x 20	1 1/4" x 3/4"	S3220BB6*	S3220HBB6*
32 x 25	1 1/4" x 1"	S3225BB6*	S3225HBB6
40 x 15	1 1/2" x 1/2"	S4015BB6*	S4015HBB6*
40 x 20	1 1/2" x 3/4"	S4020BB6*	S4020HBB6*
40 x 25	1 1/2" x 1"	S4025BB6*	S4025HBB6
40 x 32	1 1/2" x 1 1/4"	S4032BB6*	
50 x 25	2" x 1"	S5025BB6*	
50 x 32	2" x 1 1/4"	S5032BB6*	
50 x 40	2" x 1 1/2"	S5040BB6*	S5040HBB6*
65 x 50	2 1/2" x 2"	S6550BB6*	
80 x 50	3" x 2"	S8050BB6*	
80 x 65	3" x 2 1/2"	S8065BB6*	
100 x 80	4" x 1"	S10080BB6*	

* Denotes normal stock items.

Note:

- Other sizes, grades and ratings also available upon request.



BSP HEX REDUCING NIPPLE

SIZE (NOMINAL BORE)		150LB 316L
MM	INCH	
8 x 6	1/4" x 1/8	S86BHN6*
10 x 6	3/8" x 1/8"	S106BHN6*
10 x 8	3/8" x 1/4"	S108BHN6*
15 x 6	1/2" x 1/8"	
15 x 8	1/2" x 1/4"	S158BHN6*
15 x 10	1/2" x 3/8"	S1510BHN6*
20 x 8	3/4" x 1/4"	S208BHN6
20 x 10	3/4" x 3/8"	S2010BHN6*
20 x 15	3/4" x 1/2"	S2015BHN6*
25 x 8	1" x 1/4"	S208BHN6*
25 x 10	1" x 3/8"	S2510BHN6*
25 x 15	1" x 1/2"	S2515BHN6*
25 x 20	1" x 3/4"	S2520BHN6*
32 x 15	1 1/4" x 1/2"	S3215BHN6*
32 x 20	1 1/4" x 3/4"	
32 x 25	1 1/4" x 1"	S3225BHN6*
40 x 15	1 1/2" x 1/2"	S4015BHN6*
40 x 20	1 1/2" x 3/4"	S4020BHN6*
40 x 25	1 1/2" x 1"	S4025BHN6*
40 x 32	1 1/2" x 1 1/4"	S4032BHN6*
50 x 25	2" x 1"	S5025BHN6*
50 x 32	2" x 1 1/4"	S5032BHN6*
50 x 40	2" x 1 1/2"	S5040BHN6*
65 x 50	2 1/2" x 2"	
80 x 50	3" x 2"	
80 x 65	3" x 2 1/2"	
100 x 80	4" x 1"	

BSP AND SOCKET WELD PIPE FITTINGS

BSP PLUG

SIZE (NOMINAL BORE)		150LB 316L	3000LB 316L
MM	INCH		
6	1/8"	S6BPL6*	
8	1/4"	S8BPL6*	
10	3/8"	S10BPL6*	
15	1/2"	S15BPL6*	S15HBPL6*
20	3/4"	S20BPL6*	S20HBPL6*
25	1"	S25BPL6*	S25HBPL6*
32	1 1/4"	S32BPL6*	S32HBPL6*
40	1 1/2"	S40BPL6*	S40HBPL6
50	2"	S50BPL6*	
65	2 1/2"	S65BPL6*	
80	3"	S80BPL6*	
100	4"	S100BPL6*	



BSP PLUG

BSP REDUCING SOCKET

SIZE (NOMINAL BORE)		150LB 316L
MM	INCH	
8 x 6	1/4" x 1/8"	S86BS6*
10 x 6	3/8" x 1/8"	S106BS6*
10 x 8	3/8" x 1/4"	S108BS6*
15 x 6	1/2" x 1/8"	
15 x 8	1/2" x 1/4"	S158BS6*
15 x 10	1/2" x 3/8"	S1510BS6*
20 x 8	3/4" x 1/4"	S208BS6*
20 x 10	3/4" x 3/8"	
20 x 15	3/4" x 1/2"	S2015BS6*
25 x 8	1" x 1/4"	S258BS6*
25 x 10	1" x 3/8"	
25 x 15	1" x 1/2"	S2515BS6*

SIZE (NOMINAL BORE)		150LB 316L
MM	INCH	
25 x 20	1" x 3/4"	S2520BS6*
32 x 15	1 1/4" x 1/2"	
32 x 20	1 1/4" x 3/4"	S3220BS6*
32 x 25	1 1/4" x 1"	S3225BS6*
40 x 15	1 1/2" x 1/2"	
40 x 20	1 1/2" x 3/4"	S4020BS6*
40 x 25	1 1/2" x 1"	S4025BS6*
40 x 32	1 1/2" x 1 1/4"	S4032BS6*
50 x 25	2" x 1"	S5025BS6*
50 x 32	2" x 1 1/4"	
50 x 40	2" x 1 1/2"	S5040BS6*
65 x 50	2 1/2" x 2"	S6550BS6*



BSP REDUCING SOCKET



SOCKET WELD ELBOW



SOCKET WELD TEE



SOCKET WELD UNION



SOCKET WELD COUPLING

SOCKET WELD 316 3000LB

SIZE (NOMINAL BORE)		45° ELBOWS	90° ELBOWS	COUPLINGS	TEES	UNIONS
MM	INCH					
15	1/2"	S15HSE456	S15HSE6	S15HSCP6	S15HST6	S15HSU6
20	3/4"	S20HSE456*	S20HSE6	S20HSCP6	S20HST6*	S20HSU6*
25	1"	S25HSE456	S25HSE6	S25HSCP6	S25HST6	S25HSU6*
32	1 1/4"		S32HSE6			S32HSU6*
40	1 1/2"		S40HSE6	S40HSCP6	S40HST6*	
50	2"	S50HSE456*	S50HSE6	S50HSCP6	S50HST6*	S50HSU6

* Denotes normal stock items.

Note:

- Other sizes, grades and ratings also available upon request.

NPT PIPE FITTINGS



NPT WELD NIPPLE

NPT WELD NIPPLE

SIZE (NOMINAL BORE)		150LB 316
MM	INCH	
8	1/4"	S8NWN6*
10	3/8"	S10NWN6*
15	1/2"	S15NWN6*
20	3/4"	S20NWN6*
25	1"	S25NWN6*
32	1 1/4"	S32NWN6
40	1 1/2"	S40NWN6*
50	2"	S50NWN6*



NPT BARREL NIPPLE

NPT BARREL NIPPLE

SIZE (NOMINAL BORE)		150LB 316
MM	INCH	
8	1/4"	S8NBN6*
10	3/8"	S10NBN6*
15	1/2"	S15NBN6*
20	3/4"	S20NBN6*
25	1"	S25NBN6*
32	1 1/4"	S32NBN6*
40	1 1/2"	S40NBN6*
50	2"	S50NBN6*



NPT SOCKET

NPT SOCKET

SIZE (NOMINAL BORE)		150LB 316L	3000LB 316L
MM	INCH		
8	1/4"	S8NS6*	S8HNS6*
10	3/8"	S10NS6*	S10HNS6*
15	1/2"	S15NS6*	S15HNS6*
20	3/4"	S20NS6*	S20HNS6*
25	1"	S25NS6*	S25HNS6*
32	1 1/4"	S32NS6*	S32HNS6*
40	1 1/2"	S40NS6*	S40HNS6*
50	2"	S50NS6*	S50HNS6*



NPT TEE

NPT TEE

SIZE (NOMINAL BORE)		150LB 316L	3000LB 316L
MM	INCH		
8	1/4"		
10	3/8"		S10HNT6
15	1/2"	S15NT6	S15HNT6*
20	3/4"	S20NT6*	S20HNT6*
25	1"	S25NT6	S25HNT6*
32	1 1/4"		
40	1 1/2"	S40NT6*	S40HNT6*
50	2"	S50NT6*	S50HNT6*

* Denotes normal stock items.

Note:

- Other sizes, grades and ratings also available upon request.

NPT PIPE FITTINGS (CONTINUED)



NPT UNION

NPT UNION

SIZE (NOMINAL BORE)		150LB 316L	3000LB 316L
MM	INCH		
8	1/4"	S8NU6*	
10	3/8"	S10NU6	
15	1/2"	S15NU6*	S15HNU6*
20	3/4"	S20NU6*	S20HNU6*
25	1"	S25NU6*	S25HNU6*
32	1 1/4"	S32NU6*	
40	1 1/2"	S40NU6*	S40HNU6*
50	2"		S50HNU6*



NPT PLUG

NPT PLUG

SIZE (NOMINAL BORE)		150LB 316L	3000LB 316L
MM	INCH		
8	1/4"	S8NPL6*	S8HNPL6*
10	3/8"	S10NPL6*	S10HNPL6*
15	1/2"	S15NPL6*	S15HNPL6*
20	3/4"	S20NPL6*	S20HNPL6*
25	1"	S25NPL6	S25HNPL6*
32	1 1/4"	S32NPL6*	S32HNPL6*
40	1 1/2"	S40NPL6*	S40HNPL6
50	2"	S50NPL6	S50HNPL6*



NPT 90° F/F ELBOW

NPT 90° F/F ELBOW

SIZE (NOMINAL BORE)		150LB 316L	3000LB 316L
MM	INCH		
8	1/4"	S8NE6*	
10	3/8"	S10NE6*	
15	1/2"	S15NE6*	S15HNE6
20	3/4"	S20NE6*	S20HNE6*
25	1"	S25NE6	S25HNE6*
32	1 1/4"		
40	1 1/2"	S40NE6*	S40HNE6*
50	2"	S50NE6*	S50HNE6*



NPT HEX NIPPLE

NPT HEX NIPPLE

SIZE (NOMINAL BORE)		150LB 316	3000LB 316
MM	INCH		
8	1/4"	S8NHN6*	S8HNHN6*
10	3/8"	S10NHN6*	S10HNHN6*
15	1/2"	S15NHN6*	S15HNHN6*
20	3/4"	S20NHN6*	S20HNHN6*
25	1"	S25NHN6*	S25HNHN6*
32	1 1/4"	S32NHN6*	S32HNHN6*
40	1 1/2"	S40NHN6*	S40HNHN6*
50	2"	S50NHN6	S50HNHN6*

* Denotes normal stock items.

Note:

- Other sizes, grades and ratings also available upon request.

TUBE AND PIPE SUPPORTS

HYGIENIC TUBE AND PIPE HANGER

SIZE			STANDARD		BOSSED M10		BOSSED 5/8"
TUBE	OD MM	PIPE NB MM	OD	NB	OD	NB	OD
3/8"	9.52	10NB			S10THB*		
1/2"	12.7	15NB	S12TH*	S15PH*	S12THB*	S15PHB*	
5/8"	15.88		S16TH*		S16THB*		
3/4"	19.05	20NB	S19TH*	S20PH*	S19THB*	S20PHB*	
1"	25.4	25NB	S25TH*	S25PH*	S25THB*	S25PHB*	S25THB58*
1 1/4"	31.8	32NB	S32TH*	S32PH*	S32THB*	S32PHB*	S32THB58*
1 1/2"	38.1	40NB	S38TH*	S40PH*	S38THB*	S40PHB*	S38THB58*
2"	50.8	50NB	S51TH*	S50PH*	S51THB*	S50PHB*	S51THB58*
2 1/2"	63.5	65NB	S63TH*	S65PH*	S63THB*	S65PHB*	S63THB58*
3"	76.2	80NB	S76TH*	S80PH*	S76THB*	S80PHB*	S76THB58*
4"	101.6	100NB	S101TH*	S100PH*	S101THB*	S100PHB*	S101THB58*

TWO PIECE SADDLE CLAMP

SIZE				STANDARD	
TUBE	OD MM	PIPE NB MM	WIDTH/ THICK- NESS MM	OD	NB
3/8"	9.52	10NB			
1/2"	12.7	15NB			
5/8"	15.88				
3/4"	19.05	20NB			
1"	25.4	25NB	25 x 3	S25TSCPP	S25PSC*
1 1/4"	31.8	32NB			
1 1/2"	38.1	40NB	25 x 3	S38TSCPP*	S40PSC*
2"	50.8	50NB	25 x 3	S51TSCPP*	S50PSC*
2 1/2"	63.5	65NB	25 x 3	S63TSCPP*	S65PSC*
3"	76.2	80NB	25 x 5	S76TSC*	S80PSC*
4"	101.6	100NB	25 x 5	S101TSC*	S100PSC*
5"	127	125NB	38 x 5	S127TSC*	S125PSC*
6"	152.4	150NB	38 x 5	S152TSC*	S150PSC*
6"	152.4	150NB	32 x 5	S152TSCPP*	
8"	203.2	200NB	38 x 5	S203TSC*	S200PSC*
10"	254	250NB	38 x 5	S254TSC*	S250PSC
12"	304.8	300NB	38 x 5	S305TSC*	
14"	355.6	350NB	38 x 5	S355TSC*	



* Denotes normal stock items.

Notes:

- Mounting brackets are available to suit above hangers (M10, 5/8" UNC).
- Bosses: M10, 5/8" available individually.
- Grade 316 available upon request.
- Threaded rod available ex-stock.
- Sizes other than shown are available upon request.



* Denotes normal stock items.

Notes:

- Other tube saddle clamp options available:

Description	S&T Code
One way	S (mm) TS1
Two way	S (mm) TS2
Three way	S (mm) TS3



'M' BRACKET

SIZE			STANDARD	
TUBE	OD MM	PIPE NB MM	OD	NB
3/8"	9.52	10NB		
1/2"	12.7	15NB		
5/8"	15.88			
3/4"	19.05	20NB		
1"	25.4	25NB	S25TMB*	S25MPB*
1 1/4"	31.8	32NB		
1 1/2"	38.1	40NB	S38TMB*	S40MPB*
2"	50.8	50NB	S51TMB*	S50MPB*
2 1/2"	63.5	65NB	S63TMB*	
3"	76.2	80NB	S76TMB*	S80MPB*
4"	101.6	100NB	S101TMB*	S100MPB*
5"	127	125NB	S127TMB*	
6"	152.4	150NB	S152TMB*	
8"	203.2	200NB	S203TMB*	
10"	254	250NB	S254TMB*	
12"	304.8	300NB	S305TMB*	



* Denotes normal stock items.

Notes:

- Grade 316 available upon request.
- Sizes other than shown, are available upon request.

CAMLOCKS



TYPE 'A' CAMLOCK



TYPE 'C' CAMLOCK

CAMLOCK 316 FITTING

SIZE	TYPE				
OD	A	AA	AW	B	C
19.0					CAM6C019
20.0	CAM6A020			CAM6B020*	
25.0	CAM6A025			CAM6B025*	CAM6C025
32.0	CAM6A032*				CAM6C032
38.0					CAM6C038
40.0	CAM6A040*			CAM6B040*	
50.0	CAM6A050*			CAM6B050	
50.8					
51.0					CAM6C051
63.0					
76.0		CAM6AA076	CAM6AW076		CAM6C076
76.2					
80.0	CAM6A080*			CAM6B080	
100.0	CAM6A100			CAM6B100	
101.0		CAM6AA101			
101.6					CAM6C101



TYPE 'D' CAMLOCK



TYPE 'DP' CAMLOCK



TYPE 'E' CAMLOCK



TYPE 'F' CAMLOCK

SIZE	TYPE					
OD	D	DC	DCL	DP	E	F
19.0		CAM6DC019*			CAM6E019	
20.0	CAM6D020					CAM6F020*
25.0	CAM6D025*	CAM6DC025*			CAM6E025*	CAM6F025*
32.0	CAM6D032*	CAM6DC032*			CAM6E032*	CAM6F032*
38.0		CAM6DC038*			CAM6E038*	
40.0	CAM6D040*					CAM6F040*
50.0						CAM6F050*
50.8	CAM6D050*					
51.0		CAM6DC051*		CAM6DP051*	CAM6E051*	
63.0						
76.0		CAM6DC076*	CAM6DCL076	CAM6DP076*	CAM6E063*	
76.2					CAM6E076*	
80.0	CAM6D080					CAM6F080*
100.0						CAM6F100*
101.0		CAM6DC101*		CAM6DP101*	CAM6E101*	
101.6						

* Denotes normal stock items.

FLANGES

TABLE 'D' FLANGE

SIZE			SLIP ON 304L TABLE D		SLIP ON 316L TABLE D		BLIND 316L
TUBE	OD MM	PIPE NB MM	TUBE	PIPE	TUBE	PIPE	PIPE
1/2"	12.7	15NB			S127TDSTF6*		
5/8"	15.88						
3/4"	19.05	20NB		S20TDSF	S19TDSTF6*	S20TDSF6	
1"	25.4	25NB			S254TDSTF6	S25TDSF6	
1 1/4"	31.8	32NB			S318TDSTF6*	S32TDSF6	
1 1/2"	38.1	40NB			S381TDSTF6*		
2"	50.8	50NB	S508TDSTF	S50TDSF			
2 1/2"	63.5	65NB	S635TDSTF*		S635TDSTF6	S65TDSF6	S65TDBF6
3"	76.2	80NB					
4"	101.6	100NB	S1016TDTF	S100TDSF	S1016TDSTF6*	S100TDSF6*	S100TDBF6
5"	127	125NB					
6"	152.4	150NB	S1524TDSTF	S150TDSF	S1524TDSTF6*	S150TDSF6*	
8"	203.2	200NB	S2032TDSTF	S200TDSF	S2032TDSTF6	S200TDSF6*	S200TDBF6
10"	254	250NB		S250TDSF		S250TDSF6*	
12"	304.8	300NB		S300TDSF		S300TDSF6*	
14"	355.6	350NB		S350TDSF		S350TDSF6*	



TABLE 'E' FLANGE

SIZE			SLIP-ON 304L			SLIP-ON 316L			BLIND 316L	
TUBE	OD MM	PIPE NB MM	TUBE	TUBE (ID)	PIPE	TUBE	TUBE ID	PIPE	PIPE	
1/2"	12.7	15NB				S127TESTF6		S15TESF6		
3/4"	19.05	20NB	S19TESTF			S19TESTF6		S20TESF6*		
1"	25.4	25NB				S25TESF	S254TESTF6*	S25TESF6*	S25TEBF6*	
1 1/4"	31.8	32NB				S32TESF	S318TESTF6*	S32TESF6*	S32TEBF6*	
1 1/2"	38.1	40NB				S40TESF	S381TESTF6*	S40TESF6*	S40TEBF6*	
2"	50.8	50NB	S508TESTF*			S50TESF	S508TESTF6*	S50TESF6*	S50TEBF6*	
2 1/2"	63.5	65NB	S635TESTF*			S65TESF	S635TESTF6*	S65TESF6*	S65TEBF6*	
3"	76.2	80NB	S762TESTF*			S80TESF*	S762TESTF6*	S80TESF6*	S80TEBF6*	
4"	101.6	100NB	S1016TESTF*			S100TESF*	S1016TESTF6*	S100TESF6*	S100TEBF6*	
5"	127	125NB				S125TESF	S1270TESTF6*	S125TESF6*		
6"	152.4	150NB	S1524TESTF*			S150TESF*	S1524TESTF6*	S1524TESTF6ID	S150TESF6*	S150TEBF6*
8"	203.2	200NB	S2032TESTF*	S2032TESTFID*	S200TESF*	S2032TESTF6*	S2032TESTF6ID*	S200TESF6*	S200TEBF6*	
10"	254	250NB		S2540TESTFID*	S250TESF*		S2540TESTF6ID*	S250TESF6*	S250TEBF6	
12"	304.8	300NB		S3048TESTFID*	S300TESF		S3048TESTF6ID*	S300TESF6*	S300TEBF6	

* Denotes normal stock items.

Notes:

- Other sizes and drill patterns are available upon request. Fastenings available ex-stock.
- Gaskets are available ex-stock, please enquire.

FLANGES (CONTINUED)

FORGED FLANGE – PN16

SIZE			316 PN16	
TUBE	OD MM	PIPE NB MM	TUBE	PIPE
3/8"	9.52	10NB		
1/2"	12.7	15NB		S15SF166*
5/8"	15.88			
3/4"	19.05	20NB		S20SF166
1"	25.4	25NB		S25SF166
1 1/4"	31.8	32NB		S32SF166*
1 1/2"	38.1	40NB	S381TF166*	S40SF166*
2"	50.8	50NB	S508TF166*	S50SF166*
2 1/2"	63.5	65NB		S65SF166*
3"	76.2	80NB	S762TF166*	S80SF166*
4"	101.6	100NB	S1016TF166*	S100SF166*
5"	127	125NB		
6"	152.4	150NB		S150SF166*



* Denotes normal stock items.

Note:

- Other sizes and drill patterns are available upon request. Fastenings available ex-stock.

FORGED FLANGE ANSI 150

SIZE			SLIP-ON			BLIND	WELD NECK		
TUBE	OD MM	PIPE NB MM	TUBE 316 150LB	PIPE 304 150LB	PIPE 316 150LB	PIPE 316 150LB	150LB 316 SCH10	150LB 316 SCH40	300LB 316 SCH40
3/8"	9.52	10NB							
1/2"	12.7	15NB			S15SF6*	S15BF6*		S15WN6*	
5/8"	15.88								
3/4"	19.05	20NB			S20SF6*	S20BF6*		S20WN6*	
1"	25.4	25NB	S254STF6*		S25SF6*	S25BF6*		S25WN6*	
1 1/4"	31.8	32NB			S32SF6*	S32BF6*		S32WN6*	
1 1/2"	38.1	40NB	S381STF6*		S40SF6*	S40BF6*		S40WN6*	S40WF3006*
2"	50.8	50NB	S508STF6*	S50SF*	S50SF6*	S50BF6*	S50S10WN6*	S50WN6*	S50WF3006*
2 1/2"	63.5	65NB	S635STF6*		S65SF6*			S65WN6*	
3"	76.2	80NB	S762STF6*	S80SF*	S80SF6*	S80BF6*		S80WN6*	
4"	101.6	100NB	S1016STF6*	S100SF*	S100SF6*	S100BF6*	S100S10WN6*	S100WN6*	
5"	127	125NB			S125SF6*			S150WN6	
6"	152.4	150NB	S1524STF6*	S150SF*	S150SF6*	S150BF6*	S150S10WN6*		S150WF3006
8"	203.2	200NB		S200SF*	S200SF6*	S200BF6*		S200WN6*	
10"	254	250NB		S250SF*	S250SF6*	S250BF6*	S250S10WN6*	S250WN6	
12"	304.8	300NB		S300SF*	S300SF6*	S300BF6*	S300S10WN6*		

* Denotes normal stock items.

Notes:

- Other sizes and drill patterns are available upon request. Fastenings available ex-stock.
- Gaskets are available ex-stock, please enquire.

FLANGES (CONTINUED)

FLANGE NECK RING

TUBE	OD MM	PIPE NB MM	TUBE		PIPE	
			1.50MM	3.00MM	4.00MM	5.00MM
1/2"	12.7	15NB	S127NRP6			
3/4"	19.05	20NB	S19NRP6			
1"	25.4	25NB	S254NRP6*	S2543NRP6		
1 1/4"	31.8	32NB	S318NRP6*		S32NR6	
1 1/2"	38.1	40NB	S381NRP6*	S3813NRP6*	S40NR6*	
2"	50.8	50NB	S508NRP6*	S5083NRP6*	S50NR6*	
2 1/2"	63.5	65NB	S635NRP6*	S6353NRP6*	S65NR6*	
3"	76.2	80NB	S762NRP6*	S7623NRP6*	S80NR6*	
4"	101.6	100NB	S1016NRP6*	S10163NRP6	S100NR6*	
5"	127	125NB	S1270NRP6*	S12703NRP6*		
6"	152.4	150NB	S1524NRP6*	S15243NRP6*		S150NR6*
8"	203.2	200NB		S20323NRP6		S200NR6*
10"	254	250NB		S25403NRP6		S250NR6*
12"	304.8	300NB		S30483NRP6		S300NR6
14"	355.6	350NB		S35563NRP6		S350NR6*
16"	406.4	400NB				S400NR6

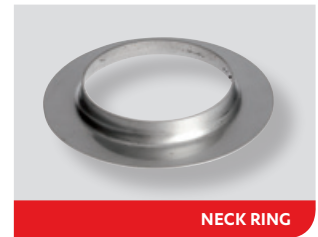

GALVANISED BACK-UP FLANGE

TUBE	OD MM	PIPE NB MM	TUBE			PIPE	
			ANSI 150# MM	TABLE E	TABLE D	150# (NB)	BLIND TABLE E
3/4"	19.05	20NB			19TDGBUTF		
1"	25.4	25NB	254GBUTF	254TEGBUTF	254TDGBUTF		
1 1/4"	31.8	32NB	381GBUTF	318TEGBUTF	318TDGBUTF		
1 1/2"	38.1	40NB	40GBUF	381TEGBUTF*	381TDGBUTF*		
2"	50.8	50NB	508GBUTF	508TEGBUTF*	508TDGBUTF	50GBUF*	
2 1/2"	63.5	65NB	635GBUTF	635TEGBUTF*	635TDGBUTF		
3"	76.2	80NB	762GBUTF*	762TEGBUTF*	762TDGBUTF		80TEGBF
4"	101.6	100NB	1016GBUTF*	1016TEGBUTF*	1016TDGBUTF	100GBUF*	
5"	127	125NB	1270GBUTF	1270TEGBUTF*	1270TDGBUTF		
6"	152.4	150NB	1524GBUTF	1524TEGBUTF*	1524TDGBUTF	150GBUF*	150TEGBF*
8"	203.2	200NB	2032GBUTF*	2032TEGBUTF*	2032TDGBUTF*		
10"	254	250NB	2540GBUTF	2540TEGBUTF	2540TDGBUTF*		250TEGBF*
12"	304.8	300NB	3048GBUTF	3048TEGBUTF	3048TDGBUTF		
14"	355.6	350NB		3556TEGBUTF			

* Denotes normal stock items.

Note:

- Other sizes and drill patterns are available upon request. Fastenings available ex-stock.

HYGIENIC TUBE

HYGIENIC WELDED TUBE TO AS 1528.1

INCH	MM	WALL THICKNESS MM	APPROX KG/M	304/L	316/L
5/16"	7.9	0.9	0.16	S799HT*	
3/8"	9.5	0.9	0.19	S959HT*	
3/8"	9.5	1.2	0.26	S9512HT*	S9512HT6*
1/2"	12.7	0.9	0.26	S1279HT*	
1/2"	12.7	1.2	0.35	S12712HT*	S12712HT6
1/2"	12.7	1.5	0.44	S12715HT*	S12715HT6*
5/8"	15.9	0.9	2.27	S1599HT*	
5/8"	15.9	1.2	0.44	S15912HT*	S15912HT6
5/8"	15.9	1.5	0.57	S15915HT*	S15915HT6*
3/4"	19.1	0.9	0.41	S199HT*	
3/4"	19.1	1.2	0.55	S1912HT*	S1912HT6
3/4"	19.1	1.5	0.69	S1915HT*	S1915HT6*
7/8"	22.0	1.2	0.65	S2212HT*	S2212HT6
7/8"	22.0	1.5	0.79	S2215HT*	S2215HT6*
1"	25.4	0.9	0.55	S2549HT	
1"	25.4	1.2	0.73	S25412HT*	S25412HT6*
1"	25.4	1.5	0.95	S25415HT*	S25415HT6*
1 1/4"	31.8	0.9	0.70	S3189HT*	S31815HT6*
1 1/4"	31.8	1.2	0.93	S31812HT*	
1 1/4"	31.8	1.5	1.23	S31815HT*	
1 1/2"	38.1	0.9	0.85	S3819HT*	
1 1/2"	38.1	1.2	1.13	S38112HT*	S38112HT6*
1 1/2"	38.1	1.5	1.49	S38115HT*	S38115HT6*
1 3/4"	44.5	1.5	1.75	S44515HT*	S44515HT6*
2"	50.8	0.9	0.89	S5089HT	
2"	50.8	1.2	1.52	S50812HT*	
2"	50.8	1.5	2.01	S50815HT*	S50815HT6*
2"	50.8	2	2.44	S5082HT*	S5082HT6*
2 1/2"	63.5	1.2	0.53	S63512HT*	
2 1/2"	63.5	1.5	2.53	S63515HT*	S63515HT6*
3"	76.2	1.2	0.44	S76212HT	
3"	76.2	1.5	3.05	S76215HT*	S76215HT6*
4"	101.6	1.5	4.09	S101615HT*	S101615HT6*
4"	101.6	2	5.02	S10162HT*	
5"	127.0	1.5	5.04	S127015HT*	S127015HT6*
6"	152.4	1.5	6.00	S152415HT*	S152415HT6*
6"	152.4	2	7.00	S15242HT*	S15242HT6*
8"	203.2	2	10.00	S20322HT*	S20322HT6*

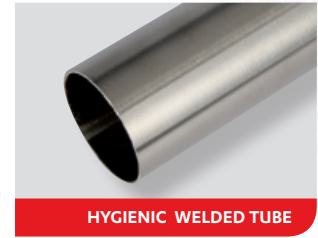

* Denotes normal stock items.

Notes:

- Manufactured to AS1528.1.
- Finish: 304/L and 316/L fully pickled and passivated.
- Length: 6m standard lengths (+25mm, -0mm), other lengths available upon request.
- Tubing supplied with a bright 320 grit (buff) polish finish.
- Finish options:
 - As welded
 - Cold-worked
 - Unpolished
 - Annealed
- Other sizes and grades available upon request.

SQUARE AND RECTANGULAR TUBE

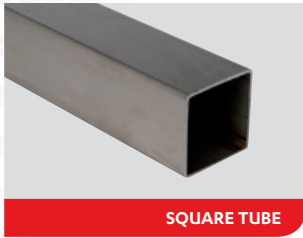

SQUARE METRIC TUBE

SIZE MM	WALL MM	304	316
25.0 x 25.0	3.00	S253S*	
30.0 x 30.0	1.50	S3015S*	
35.0 x 35.0	1.50	S3515S	
40.0 x 40.0	2.00		S402S6
50.0 x 50.0	1.50		S5015S6*
50.0 x 50.0	2.00	S502S*	
50.0 x 50.0	3.00	S503S*	S503S6*
60.0 x 60.0	2.00	S602S*	
60.0 x 60.0	3.00	S603S*	
75.0 x 75.0	2.00	S752S*	S752S6*
75.0 x 75.0	3.00	S753S*	S753S6*
75.0 x 75.0	5.00	S755S*	
80.0 x 80.0	2.00	S802S	
80.0 x 80.0	3.00	S803S*	
100.0 x 100.0	3.00	S1003S*	S1003S6*
100.0 x 100.0	4.00	S1004S*	
100.0 x 100.0	5.00	S1005S*	
150.0 x 150.0	3.00	S1503S*	
150.0 x 150.0	5.00	S1505S*	

SQUARE IMPERIAL TUBE

SIZE MM	WALL MM	304	316
12.7 x 12.7	1.20	S12712S*	
19.0 x 19.0	1.20	S1912S*	
19.0 x 19.0	1.50	S1915S*	
25.4 x 25.4	1.20	S25412S*	
25.4 x 25.4	1.50	S25415S*	S25415S6*
25.4 x 25.4	3.00	S2543S	
31.8 x 31.8	1.20	S31812S*	
31.8 x 31.8	1.50	S31815S*	S31815S6*
38.0 x 38.0	1.50		S3815S6
38.0 x 38.0	3.00	S383S*	S383S6*
38.1 x 38.1	1.20	S38112S*	
38.1 x 38.1	1.50	S38115S*	S38115S6*
38.1 x 38.1	3.00	S3813S*	
50.8 x 50.8	1.50		S50815S6*
50.8 x 50.8	3.00	S5083S*	
63.5 x 63.5	2.00	S6352S	

RECTANGULAR METRIC AND IMPERIAL TUBE

SIZE MM	WALL MM	304	316
40.0 x 20.0	1.50	S402015R*	
50.0 x 25.0	1.50	S502515R*	S502515R6*
50.0 x 25.0	2.00	S50252R*	
50.0 x 25.0	3.00	S50253R*	S50253R6
50.8 x 25.4	1.20	S50825412R*	
50.8 x 25.4	1.50	S50825415R*	S50825415R6*
50.8 x 25.4	3.00	S5082543R*	
60.0 x 40.0	3.00	S60403R*	
80.0 x 40.0	2.00	S80402R*	
80.0 x 40.0	3.00	S80403R*	S80403R6
100.0 x 50.0	2.00	S100502R	
100.0 x 50.0	3.00	S100503R	
100.0 x 50.0	5.00	S100505R	
150.0 x 100.0	5.00	S1501005R*	

* Denotes normal stock items.

Note:

- Other sizes and grades are available upon request.

SPIRAL WELDED TUBE

SPIRAL WELDED TUBE TO AS 1530

INCH	MM	WALL THICKNESS MM	APPROX. KG/M	304/L	316/L
4"	101.6	3.0	7.8	S10163SWT	
5"	127.0	2.0	6.4	S12702SWT*	S12702SWT6*
6"	152.4	1.5	6.1		
6"	152.4	2.0	7.7	S15242SWT*	S15242SWT6
6"	152.4	3.0	11.7		S15243SWT6
8"	203.2	2.0	10.2	S20322SWT*	S20322SWT6
8"	203.2	3.0	15.6	S20323SWT	S20323SWT6
10"	254.0	2.0	12.8	S25402SWT*	S25402SWT6
10"	254.0	3.0	19.5	S25403SWT*	S25403SWT6
12"	304.8	2.0	15.4	S30482SWT*	S30482SWT6
12"	304.8	3.0	23.4	S30483SWT*	S30483SWT6
14"	355.6	2.0	18.0	S35562SWT	S35562SWT6
14"	355.6	3.0	27.3	S35563SWT	S35563SWT6
16"	406.4	2.0	20.8	S40642SWT	
16"	406.4	3.0	31.2	S40643SWT*	
18"	457.2	2.0	23.1	S45723SWT	S45723SWT6
18"	457.2	4.0	45.8		
20"	508.0	2.0	25.0	S50803SWT	
20"	508.0	3.0	39.0		S50803SWT6
24"	609.6	3.0	46.5	S60963SWT	S60963SWT6

* Denotes normal stock items.

Notes:

- The full range is available by enquiry.
- Additional services:
Polishing available – lead times may apply.
- Tolerances:
 - Diameter: Maximum +/- 0.75%.
 - Length: +10mm -0, available in 6 metres up to 10 metres long.
- Material: As specified - material certificates issued upon request.
- Protection: Each length inspected prior to complete immersion, to chemically descale and passivate the internal and external surfaces of the pipe.
- Packaging: Either loose or securely packaged on pallets.
- Schedule: Pipe sizes up to 4mm thick available.
- Fittings: Bends, reducers, tees, neck rings, and flanges available.
- Also manufactured in 2205.
- Other sizes and grades available upon request.

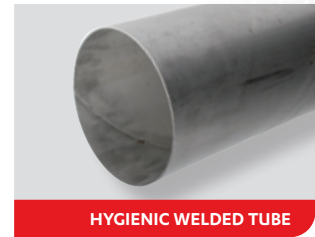

HYGIENIC WELDED TUBE

SEAMLESS TUBE



SEAMLESS IMPERIAL TUBE

SEAMLESS IMPERIAL 316 TUBE (COLD-DRAWN ANNEALED AND PICKLED)

SIZE (OD)		WALL THICKNESS			
TUBE	OD MM	25SWG (0.508MM)	20SWG (0.914MM)	18SWG (1.22MM)	16SWG (1.63MM)
1/8"	3.18	S1825ST6*			
3/16"	4.76		S31620ST6*	S31618ST6*	
1/4"	6.35		S1420ST6*	S1418ST6*	S1416ST6*
5/16"	7.94		S51620ST6*	S51618ST6*	S51616ST6
3/8"	9.52		S3820ST6*	S3818ST6*	S3816ST6*
1/2"	12.70		S1220ST6*	S1218ST6*	S1216ST6*
5/8"	15.88			S5818ST6*	S5816ST6*
3/4"	19.05				S3416ST6*
1"	25.40				S116ST6*
1 1/8"	28.60			S28612ST*	
1 1/2"	38.10			S38112ST	

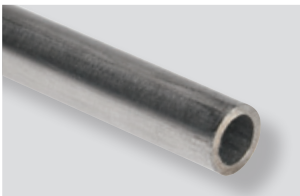

SEAMLESS METRIC TUBE

SEAMLESS METRIC 316 TUBE (COLD-DRAWN ANNEALED AND PICKLED)

SIZE (OD)	WALL THICKNESS		
OD MM	0.40MM	1.00MM	1.50MM
5.00	S54ST6*		
6.00		S61ST6*	S615ST6*
8.00			S815ST6*
10.00			S1015ST6*
12.00			S1215ST6*
15.00			S1515ST6
18.00		S181ST6	
22.00			S2215ST6

* Denotes normal stock items.

Notes:

- 'SWG' refers to the Imperial Standard Wire Gauge.
- Other sizes and grades available upon request.
- Length: 6 metres standard lengths.
- Bright finish.

TUBE BENDS



90 DEGREE TUBE BEND



180 DEGREE TUBE BEND

90° HYGIENIC BUTT WELD TUBE BEND

INCH	MM	WALL THICKNESS MM	SPEC	CENTRE LINE RADIUS MM	CENTRE TO FACE MM	304	316	LONG LEG 304 BENDS
1/2"	12.7	1.20	AS1528	19.05	49.05	S12712TB90*		
1/2"	12.7	1.50	AS1528	19.05	49.05	S12715TB90*	S12715TB906*	
5/8"	15.9	1.20	AS1528	23.8	53.8		S15912TB906	
5/8"	15.9	1.50	AS1528	23.8	58.65	S15915TB90*	S15915TB906*	
3/4"	19.0	1.20	AS1528	28.65	58.65	S19012TB90		
3/4"	19.0	1.50	AS1528	28.65	58.65	S19015TB90*	S1915TB906*	
1"	25.4	1.20	AS1528	38.1	65.3	S25412TB90		S25412TB90LL*
1"	25.4	1.50	AS1528	38.1	65.3	S25415TB90*	S25415TB906*	
1 1/4"	31.8	1.2	NZ DIM	57.1	89	S31812TB90*	S31815TB906*	S31812TB90LL*
1 1/4"	31.8	1.5	NZ DIM	57.1	89	S31815TB90*		
1 1/2"	38.1	1.2	NZ DIM	76.1	110	S38112TB90*	S38115TB906*	S38112TB90LL*
1 1/2"	38.1	1.5	NZ DIM	76.1	110	S38115TB90*		
1 3/4"	44.5	1.5	NZ DIM	79.4	118	S44515TB90*	S44515TB906*	
2"	50.8	1.2	NZ DIM	101.6	133	S50812TB90	S50815TB906*	S50812TB90LL*
2"	50.8	1.5	NZ DIM	101.6	133	S50815TB90*		
2 1/2"	63.5	1.5	NZ DIM	114.3	152	S63515TB90*	S63515TB906*	S63512TB90LL*
3"	76.2	1.5	NZ DIM	139.7	178	S76215TB90*	S76215TB906*	S76215TB90LL*
4"	101.6	1.5	AS1528	152.4	178	S101615TB90*	S101615TB906*	S101615TB90LL*
5"	127.0	1.5	AS1528	190.5	235	S127015TB90*		
6"	152.4	2	AS1528	229	273	S15242TB90*	S15242TB906*	
8"	203.4	2	AS1528	300	375	S20342TB90*	S20342TB906*	

180° HYGIENIC BUTT WELD TUBE BEND

INCH	MM	WALL THICKNESS MM	SPEC	CENTRE LINE RADIUS MM	CENTRE TO FACE MM	304	316
1"	25.4	1.50	NZ DIM	44.5	66.7	S25415TB180*	S25415TB1806*
1 1/4"	31.8	1.50	NZ DIM	57.2	89	S31815TB180*	S31815TB1806
1 1/2"	38.1	1.50	NZ DIM	76.2	111.1	S38115TB180*	S38115TB1806*
2"	50.8	1.50	NZ DIM	101.6	133.4	S50815TB180*	S50815TB1806*
2 1/2"	63.5	1.50	NZ DIM	114.3	152.4	S63515TB180*	S63515TB1806*
3"	76.2	1.50	NZ DIM	139.7	177.8	S76215TB180*	S76215TB1806*
4"	101.6	1.50	AS1528	152.4	177.8	S101615TB180*	S101615TB1806*

* Denotes normal stock items.

Notes:

- 'NZ DIM' = NZ dimensions.
- AS1528 Bends from 31.8-76.2mm available by enquiry.
- Please refer to page 74 and 75 for properties and dimensions.
- Other sizes and grades available upon request.

TUBE BENDS (CONTINUED)

90° LARGE (ID) BENDS HYGIENIC BUTT WELD TUBE BEND TO ASTM A774

INCH	MM	WALL THICKNESS MM	CENTRE LINE RADIUS MM	304	316
5"	125.0	2.00	189.0		S1252TB906ID
6"	152.4	2.00	228.6	S15242TB90ID	S15242TB906ID
6"	152.4	3.00	228.6	S15243TB90ID*	S15243TB906ID
8"	203.2	2.00	304.8	S20322TB90ID*	S20322TB906ID*
8"	203.2	3.00	304.8	S20323TB90ID	S20323TB906ID*
10"	254.0	2.00	381.0	S2542TB90ID	S2542TB906ID*
10"	254.0	3.00	381.0	S2543TB90ID*	S2543TB906ID*
12"	304.8	2.00	457.2	S30482TB90ID	S30482TB906ID
12"	304.8	3.00	457.2	S30483TB90ID*	S30483TB906ID*
14"	355.6	4.70	533.0	S40643TB90ID*	
16"	406.4	3.00	609.6	S45723TB90ID	

* Denotes normal stock items.

Notes:

- ID Bends available in grades 304 and 316 in selected sizes:
 - 304 Product Code: S(ID)(Wall)TB45ID.
 - 316 Product Code: S(ID)(Wall)TB456ID.
- 45° Large (ID) Bends are available by enquiry.



90 DEGREE ID TUBE BEND

45° HYGIENIC BUTT WELD TUBE BEND TO AS1528.3

INCH	MM	WALL THICKNESS MM	CENTRE LINE RADIUS MM	304	316
3/4"	19.0	1.5	38.1	S1915TB45	S1915TB456*
1"	25.4	1.5	57.2	S25415TB45*	S25415TB456*
1 1/4"	31.8	1.5	57.2	S31815TB45*	S31815TB456*
1 1/2"	38.1	1.5	76.2	S38115TB45*	S38115TB456*
2"	50.8	1.5	95.3	S50815TB45*	S50815TB456*
2 1/2"	63.5	1.5	114.3	S63515TB45*	S63515TB456*
3"	76.2	1.5	139.7	S76215TB45*	S76215TB456*
4"	101.6	1.5	152.4	S101615TB45*	S101615TB456*
6"	152.4	2	228.6	S15242TB45*	S15242TB456*

* Denotes normal stock items.

Note:

- Other sizes and grades are available upon request.

45° HYGIENIC BUTT WELD LONG LEG TUBE BEND

INCH	MM	WALL THICKNESS MM	CENTRE LINE RADIUS MM	304
1 1/4"	31.8	1.2	57.2	
1 1/2"	38.1	1.2	76.2	S38112TB45LL
2"	50.8	1.2	101.6	S50812TB45LL
2 1/2"	63.5	1.2	114.3	S63512TB45LL

* Denotes normal stock items.

Note:

- Other sizes and grades are available upon request.

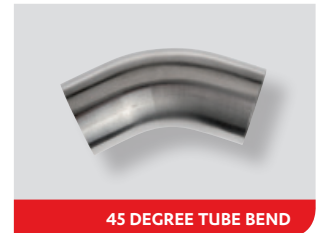

45 DEGREE TUBE BEND

TUBE BENDS (CONTINUED)

90° SHORT RADIUS HYGIENIC BUTT WELD TUBE BEND

INCH	MM	WALL THICKNESS MM	CENTRE LINE RADIUS MM	304	316
1"	25.4	1.5	38.1	S25415TB90SR*	S25415TB906SR*
1 1/4"	31.8	1.5	47.6	S31815TB90SR*	S31815TB906SR*
1 1/2"	38.1	1.5	57.15	S38115TB90SR*	S38115TB906SR*
2"	50.8	1.5	76.2	S50815TB90SR*	S50815TB906SR*
2 1/2"	63.5	1.5	95.25	S63515TB90SR*	S63515TB906SR*
3"	76.2	1.5	114.3	S76215TB90SR*	S76215TB906SR*
4"	101.6	1.5	152.4	S101615TB90SR*	S101615TB906SR*
5"	127.0	2.0	228.6		S12702TB906SR*



HYGIENIC BUTT WELD EQUAL SWEPT TEE

INCH	MM	WALL THICKNESS MM	LEG LENGTH FROM TEE CENTRE MM	316
1/2"	12.7	1.5	35.0	S12715TT6*
5/8"	15.8	1.5	40.0	S1615TT6*
3/4"	19	1.5	45.0	S1915TT6*
1"	25.4	1.5	50.0	S25415TT6*
1 1/4"	31.8	1.5	57.5	S31815TT6*
1 1/2"	38.1	1.5	65.0	S38115TT6*
2"	50.8	1.5	80.0	S50815TT6*
2 1/2"	63.5	1.5	100.0	S63515TT6*
3"	76.2	1.5	115.0	S76215TT6*
4"	101.6	1.5	140.0	S1016TT6*
5"	127	1.5	152.0	
6"	152.4	2.0	170.0	S1522TT6*



HYGIENIC BUTT WELD PULLED SPIGGOT TEE

INCH	MM	WALL THICKNESS MM	LEG LENGTH FROM TEE CENTRE MM	316
1"	25.4	1.5	18.9	S25415TTP6*
1 1/4"	31.8	1.5	21.5	S31815TTP6*
1 1/2"	38.1	1.5	28.5	S38115TTP6*
2"	50.8	1.5	35.5	S50815TTP6*
2 1/2"	63.5	1.5	42.5	S63515TTP6*
3"	76.2	1.5	57.0	S76215TTP6*
4"	101.6	1.5	70.0	S101615TTP6*
5"	127	1.5	85.0	S127015TTP6*
6"	152.4	1.5	85.0	S15215TTP6
6"	152.4	2.0	85.0	S1522TTP6*
8"	203.2	2.0	114.0	S20322TTP6*



* Denotes normal stock items.

Note:

- Other sizes and grades available upon request.

HYGIENIC TUBE REDUCERS

HYGIENIC BUTT WELD TUBE ECCENTRIC AND CONCENTRIC REDUCER

INCH	MM	WALL THICKNESS MM	LEG LENGTH MM	316 ECCENTRIC REDUCERS	316 CONCENTRIC REDUCERS
3/4" x 1/2"	19.0 x 12.7	1.5	25		S19127TCR6*
3/4" x 5/8"	19.0 x 16.0	1.5	25		S19159TCR6*
1" x 1/2"	25.4 x 12.7	1.5	25	S254127TER6*	S254127TCR6*
1" x 5/8"	25.4 x 16.0	1.5	25		S25416TCR6*
1" x 3/4"	25.4 x 19.0	1.5	25	S25419TER6*	S25419TCR6*
1 1/4" x 3/4"	31.8 x 19.0	1.5	30		S31819TCR6*
1 1/4" x 1"	31.8 x 25.4	1.5	30	S318254TER6*	S318254TCR6*
1 1/2" x 3/4"	38.1 x 19.0	1.5	30	S381254TER6*	S38119TCR6*
1 1/2" x 1"	38.1 x 25.4	1.5	30		S381254TCR6*
1 1/2" x 1 1/4"	38.1 x 31.8	1.5	30	S381318TER6*	S381318TCR6*
1 3/4" x 1 1/2"	44.4 x 38.1	1.5	30		
2" x 3/4"	50.8 x 19.0	1.5	40		S50819TCR6*
2" x 1"	50.8 x 25.4	1.5	40	S508254TER6*	S508254TCR6*
2" x 1 1/4"	50.8 x 31.8	1.5	40	S508318TER6*	S508318TCR6*
2" x 1 1/2"	50.8 x 38.1	1.5	40	S508381TER6*	S508381TCR6*
2 1/2" x 1"	63.5 x 25.4	1.5	50	S635254TER6*	S635254TCR6*
2 1/2" x 1 1/4"	63.5 x 31.8	1.5	50		S635318TCR6*
2 1/2" x 1 1/2"	63.5 x 38.1	1.5	50	S635381TER6*	S635381TCR6*
2 1/2" x 2"	63.5 x 50.8	1.5	50	S635508TER6*	S635508TCR6*
3" x 1"	76.2 x 25.4	1.5	60	S762254TER6*	S762254TCR6*
3" x 1 1/2"	76.2 x 38.1	1.5	60	S762381TER6*	S762381TCR6*
3" x 2"	76.2 x 50.8	1.5	60	S762508TER6*	S762508TCR6*
3" x 2 1/2"	76.2 x 63.5	1.5	60	S762635TER6*	S762635TCR6*
4" x 1"	101.6 x 25.4	1.5	70	S1016254TER6*	S1016254TCR6*
4" x 1 1/2"	101.6 x 38.1	1.5	70	S1016381TER6*	S1016381TCR6*
4" x 2"	101.6 x 50.8	1.5	70	S1016508TER6*	S1016508TCR6*
4" x 2 1/2"	101.6 x 63.5	1.5	70	S1016635TER6*	S1016635TCR6*
4" x 3"	101.6 x 76.2	1.5	70	S1016762TER6*	S1016762TCR6*
5" x 2"	127.0 x 50.8	2	100		S12705082TCR6
5" x 2 1/2"	127.0 x 63.5	1.5	100		
5" x 2 1/2"	127.0 x 63.5	2	100		S12706352TCR6
5" x 3"	127.0 x 76.2	1.5	100	S12707622TER6*	S127076215TCR6*
5" x 3"	127.0 x 76.2	2	100		S12707622TCR6
5" x 4"	127.0 x 101.6	2	100	S127010162TER6*	S127010162TCR6*
6" x 2"	152.4 x 50.8	2	120		S15245082TCR6*
6" x 2 1/2"	152.4 x 63.5	2	120		S15246352TCR6
6" x 3"	152.4 x 76.2	2	120	S15247622TER6*	S15247622TCR6*
6" x 4"	152.4 x 101.6	2	120	S152410162TER6*	S152410162TCR6*
6" x 5"	152.4 x 127.0	2	120	S15241272TER6	S15241272TCR6*
8" x 4"	203.0 x 101.6	2	150		
8" x 6"	203.0 x 152.4	2	150	S203215242TER6*	



* Denotes normal stock items.

Note:

- Other sizes and grades available upon request.

HYGIENIC TEES AND HOSETAILS

HYGIENIC REDUCING PULLED TEE

INCH	MM	WALL THICKNESS MM	316
1 1/2" x 1"	38.1 x 25.4	1.5	S38125415TTP6*
2" x 1"	50.8 x 25.4	1.5	S50825415TTP6*
2" x 1 1/2"	50.8 x 38.1	1.5	S50838115TTP6*
2 1/2" x 1"	63.5 x 25.4	1.5	S63525415TTP6*
2 1/2" x 1 1/2"	63.5 x 38.1	1.5	S63538115TTP6*
2 1/2" x 2"	63.5 x 50.8	1.5	S63550815TTP6*
3" x 1"	76.2 x 25.4	1.5	S76225415TTP6*
3" x 1 1/2"	76.2 x 38.1	1.5	S76238115TTP6*
3" x 2"	76.2 x 50.8	1.5	S76250815TTP6*
3" x 2 1/2"	76.2 x 63.5	1.5	S76263515TTP6*
4" x 1"	101.6 x 25.4	1.5	S101625415TTP6*
4" x 1 1/2"	101.6 x 38.1	1.5	S101638115TTP6*
4" x 2"	101.6 x 50.8	1.5	S101650815TTP6*
4" x 2 1/2"	101.6 x 63.5	1.5	S101663515TTP6*
4" x 3"	101.6 x 76.2	1.5	S101676215TTP6*
6" x 4"	152.4 x 101.6	2.0	S152410162TTP6*
8" x 6"	203.0 x 152.4	2.0	S203215242TTP6*



HYGIENIC SWAGED HOSETAIL

SIZE (OUTSIDE DIAMETER)		316
INCH	OD MM	
1"	25.4	S254THS6*
1 1/2"	38.1	S381THS6*
2"	50.8	S508THS6*
2 1/2"	63.5	S635THS6*
3"	76.2	S762THS6*
4"	101.6	S1016THS6*



* Denotes normal stock items.

Note:

- Other sizes and grades available upon request.



KLEANFLOW™ DAIRY FITTINGS

RJT TUBE UNION

RJT tube unions (Ring Joint Type), with their Whitworth thread, are made for easy assembly and dismantling for cleaning purposes. The RJT tube unions comprise four parts – a male part, a liner, an O-ring seal and a hexagonal or slotted nut.



RJT TUBE UNIONS



KLEANFLOW™ HEXAGON NUT



KLEANFLOW™ SLOTTED NUT

KLEANFLOW™ RJT TUBE UNION NUT

SIZE		304 SLOTTED NUT	304 HEX NUT
INCH	OD MM		
25.4	1"	S254SN*	S254HN*
38.1	1 1/2"	S381SN*	S381HN*
50.8	2"	S508SN*	S508HN*
63.5	2 1/2"	S635SN*	S635HN*
76.2	3"	S762SN*	S762HN*
101.6	4"	S1016SN*	S1016HN*
127	5"	S1270SN*	
152.4	6"	S1524SN*	S1524HN*



KLEANFLOW™ SANITARY LINER



KLEANFLOW™ MALE PART

KLEANFLOW™ RJT TUBE UNION LINER

SIZE		316 SANITARY	316 BLANK	316 FLAT FACED
INCH	OD MM			
1"	25.4	S254SL*	S254BL*	S254FFL*
1 1/2"	38.1	S381SL*	S381BL*	S381FFL*
2"	50.8	S508SL*	S508BL*	S508FFL*
2 1/2"	63.5	S635SL*	S635BL*	S635FFL*
3"	76.2	S762SL*	S762BL*	S762FFL*
4"	101.6	S1016SL*	S1016BL*	S1016FFL*
5"	127	S1270SL*	S127BL*	S1270FFL*
6"	152.4	S1524SL*	S1524BL*	S1524FFL*

KLEANFLOW™ RJT TUBE UNION MALE PART

SIZE		316 FLAT FACED	316 MALE PART
INCH	OD MM		
1"	25.4	S254FFMP*	S254MP*
1 1/2"	38.1	S381FFMP*	S381MP*
2"	50.8	S508FFMP*	S508MP*
2 1/2"	63.5	S635FFMP*	S635MP*
3"	76.2	S762FFMP*	S762MP*
4"	101.6	S1016FFMP*	S1016MP*
5"	127	S1270FFMP*	S1270MP*
6"	152.4	S1524FFMP*	S1524MP*

SMS UNION

The SMS union is the Swedish standard hygienic fitting. It can be recognised by the round slotted nut and square section joint ring. The coupling provides a crevice free joint originally designed for applications where frequent dismantling for cleaning is not necessary.

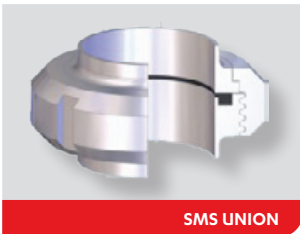

SMS UNION

KLEANFLOW™ SMS TUBE UNION

SIZE		304 SLOTTED NUT	316 LINER	316 MALE PART
INCH	OD MM			
1"	25.4	S254SSN*	S254SSL*	S254SMP*
1 1/2"	38.1			
2"	50.8	S508SSN*	S508SSL*	S508SMP
2 1/2"	63.5	S635SSN*	S635SSL*	S635SMP*
3"	76.2	S762SSN*	S762SSL*	S762SMP
4"	101.6	S1016SSN*	S1016SSL*	S1016SMP*
5"	127			
6"	152.4	S1524SSN*	S1524SSL*	S1524SMP*

* Denotes normal stock items.

Note:

- DIN and flat faced unions are also available - please enquire with your local Steel & Tube branch.

KLEANFLOW™ DAIRY FITTINGS (CONTINUED)

KLEANFLOW™ RJT TUBE UNION SEAL

SIZE		BLUE NITRILE	GREEN EPDM	TEFLON	FLAT FACED	SMS
INCH	OD MM					
1"	25.4	S254SSB*	S254SSE*	S254SST	S254FFS*	S254SS
1 1/2"	38.1	S381SSB*	S381SSE*	S381SST	S381FFS*	
2"	50.8	S508SSB*	S508SSE*	S508SST	S508FFS*	S508SS
2 1/2"	63.5	S635SSB*	S635SSE*	S635SST	S635FFS*	S635SS*
3"	76.2	S762SSB*	S762SSE*	S762SST	S762FFS*	S762SS*
4"	101.6	S1016SSB*	S1016SSE*	S1016SST	S1016FFS*	S1016SS*
5"	127	S1270SSB*	S1270SSE*		S1270FFS*	
6"	152.4	S1524SSB*	S1524SSE*	S1524SST*	S1524FFS*	S1524SS*



KLEANFLOW™ SANITARY SEALS

KLEANFLOW™ RJT TUBE UNION O-RING

SIZE		BLUE NITRILE	GREEN EPDM
OD MM	INCH		
1"	25.4	S254RB*	S254RE*
1 1/2"	38.1	S381RB*	S381RE*
2"	50.8	S508RB*	S508RE*
2 1/2"	63.5	S635RB*	S635RE*
3"	76.2	S762RB*	S762RE*
4"	101.6	S1016RB*	S1016RE*
6"	152.4	S1524RB	



KLEANFLOW™ O-RING

* Denotes normal stock items.

RJT NUT WRENCH AND SPANNER



KLEANFLOW™ HEX NUT SPANNER

SUITS HEX NUT 1"-6"



KLEANFLOW™ UNIVERSAL WRENCH

SUITS SLOTTED NUT 1"-4"
Product Code: SUW



KLEANFLOW™ ADJ. SPANNER (ECONO)

SUITS SLOTTED NUT 1"-6"
Product Code: SAS

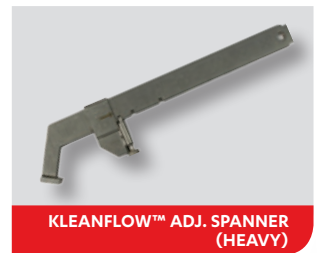

KLEANFLOW™ ADJ. SPANNER (HEAVY)

SUITS SLOTTED NUT 1"-6"
Product Code: SASH (HEAVY)

SIZE		HEX NUT SPANNER
INCH	OD MM	
1"	25.4	S254SHN*
1 1/2"	38.1	S381SHN*
2"	50.8	S508SHN*
2 1/2"	63.5	S635SHN*
3"	76.2	S762SHN*
4"	101.6	S1016SHN*

KLEANFLOW™ DAIRY FITTINGS (CONTINUED)

Tri-Clamp fittings provide a crevice free joint and quick method to regularly open up a system for ease of maintenance for blockage free lines. The fittings comprise of four parts – two welding ferrules, a seal ring and the bolted Tri-Clamp.

* Denotes normal stock items.

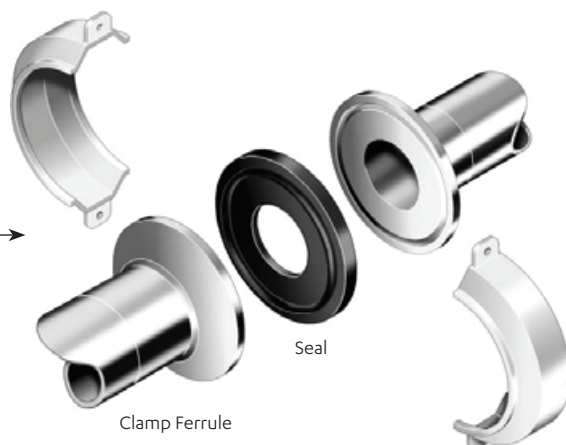

KLEANFLOW™ TRI-CLAMP

SIZE		304 TRI-CLAMP	304 HIGH PRESSURE TRI-CLAMP	TRI-BLANK
INCH	OD MM			
1/2"	12.7	S127TC*		S127TB*
1"	25.4	S254TC*	S1TC*	S254TB*
2"	50.8	S508TC*	S2TC*	S508TB*
2 1/2"	63.5	S635TC*	S212TC*	S635TB*
3"	76.2	S762TC*	S3TC*	S762TB*
4"	101.6	S1016TC*	S4TC*	S1016TB*
5"	127	S1270TC*		S1270TB*
6"	152.4	S1524TC*	S6TC*	S1524TB*
8"	203.2	S2032TC*		S2032TB*

• Tri-Clamps; 12.7mm (1/2") adjustable to fit 19.0mm (3/4") or 25.4mm (1") adjustable to fit 38.1mm (1 1/2") OD.

KLEANFLOW™ TRI-CLAMP SEAL

SIZE		BLACK EPDM
INCH	OD MM	
1/2"	12.7	S127TCSE*
3/4"	19.0	S19TCSE*
1"	25.4	S254TCSE*
1 1/4"	31.8	S318TCSE*
1 1/2"	38.1	S381TCSE*
2"	50.8	S508TCSE*
2 1/2"	63.5	S635TCSE*
3"	76.2	S762TCSE*
4"	101.6	S1016TCSE*
5"	127.0	S1270TCSE*
6"	152.4	S1524TCSE*
8"	203.2	S2032TCSE*



KLEANFLOW™ TRI-CLAMP FERRULE

SIZE		SHORT		MEDIUM		LONG		RECESSLESS
INCH	OD MM	CODE	LENGTH MM	CODE	LENGTH MM	CODE	LENGTH MM	CODE
1/2"	12.7				21.5	S127TCFL*	28.6	
3/4"	19.0	S19TCFS*	12.7			S19TCFL*	28.6	
1"	25.4	S254TCFS*	12.7	S254TCFM*	21.5	S254TCFL*	28.6	
1 1/4"	31.8	S318TCFS*	12.7					S318TCFE*
1 1/2"	38.1	S381TCFS*	12.7	S381TCFM*	21.5	S381TCFL*	28.6	S381TCFE*
2"	50.8	S508TCFS*	12.7	S508TCFM*	21.5	S508TCFL*	28.6	S508TCFE*
2 1/2"	63.5	S635TCFS*	12.7	S635TCFM*	21.5	S635TCFL*	28.6	S635TCFE*
3"	76.2	S762TCFS*	12.7	S762TCFM*	21.5	S762TCFL*	28.6	S762TCFE*
4"	101.6	S1016TCFS*	16.0	S1016TCFM*	21.5	S1016TCFL*	28.6	S1016TCFE*
5"	127					S1270TCFL*	38.1	
6"	152.4	S1524TCFS*	21.0	S1524TCFM*	28.6	S1524TCFL*	38.1	
8"	203.2			S2032TCFM*	28.6			
10"	254			S2540TCFM*	28.6			

KLEANFLOW™ DAIRY FITTINGS (CONTINUED)



HYGIENIC BUTT WELD FERRULE TRI-CLAMP TUBE BEND AND TEE

INCH	MM	WALL THICKNESS MM	CENTRE LINE RADIUS MM	CENTRE TO FACE MM	304
90° FERRULE TUBE BEND					
1 1/2"	38.1	1.5	76.1	110	S38115TBF90*
2"	50.8	1.5	101.6	133	S50815TBF90*
45° FERRULE TUBE BEND					
1 1/2"	38.1	1.5	76.2		S38115TBF45*
2"	50.8	1.5	95.3		S50815TBF45*
FERRULE TEE					
1 1/2"	38.1	1.5	51.0		S38115TTF
2"	50.8	1.5	63.5		S50815TTF*

* Denotes normal stock items.

Notes:

- Selected sizes of ferruled tube bends to suit Tri-Clamp fittings are available in grade 304: – 304 Product Code: S(OD)(Wall)TBF90.
- Selected sizes of ferruled tube bends to suit Tri-Clamp fittings are available in grade 304: – 304 Product Code: S(OD)(Wall)TBF45.
- Selected sizes of ferruled tube tees to suit Tri-Clamp fittings are available in grade 304: – 304 Product Code: S(OD)(Wall)TTF.

PIPETITE™

Flexible, self-sealing wall boots for pipe penetrations in hygienic environments.

PIPETITE™ WALL ENTRY FLANGE

SIZE MM	CODE	DIMENSIONS MM			
		A	B	C	D
0-25	S25WEFSC6*	30	57	70	52
0-65	S65WEF*	64	91	106	60
0-95	S95WEF*	100	128	147	78
70-135	S135WEF*	140	168	187	64
100-180	S180WEF*	180	213	237	84

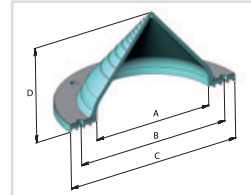

WALL ENTRY FLANGE

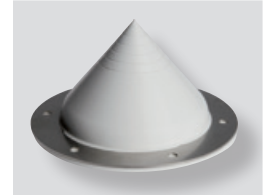

WALL ENTRY FLANGE

PIPETITE™ PIPE REDUCER

SIZE MM	CODE	DIMENSIONS MM			
		A	B	C	D
25 x 0-20		-	-	-	-
65 x 0-50		-	-	-	-
100 x 0-75	S101PRS*	90	-	102	112
150 x 0-135	S152PRS*	141	-	153	150
200 x 0-180		-	-	-	-

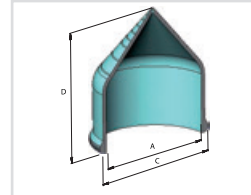

PIPE REDUCER



PIPE REDUCER

PIPETITE™ REBOOT

SIZE MM	CODE	DIMENSIONS MM			
		A	B	C	D
0-65	S65WER*	-	-	-	-
0-95	S95WER*	100	128	147	78
70-135	S135WER*	140	168	187	64
100-180	S180WER*	180	213	237	84
165-380	S380WER*	434	467	490	200

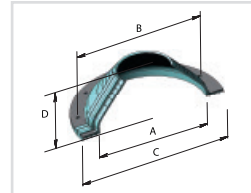

REBOOT

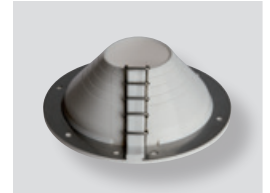

REBOOT

PIPETITE™ GROMMET

SIZE MM	CODE	DIMENSIONS MM			
		A	B	C	D
0-25	S25PG*	48	36	1.2 - 3.0	45
0-65	S65PG*	82	70	1.2 - 3.0	57
0-95	S95PG*	120	106	1.2 - 3.0	75
70-135	S135PG*	160	146	1.2 - 3.0	61
100-180	S180PG*	202	186	1.2 - 3.0	77

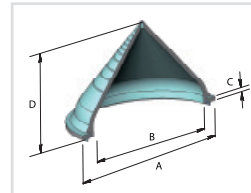

GROMMET



GROMMET

PIPETITE™ PNEUMATIC GROMMET

SIZE MM	CODE	DIMENSIONS MM			
		A	B	C	D
6	S6PPG*	22	16	1.2 - 3.0	33
8	S8PPG*	22	16	1.2 - 3.0	31
10		22	16	1.2 - 3.0	32
12		22	16	1.2 - 3.0	30

- * Denotes normal stock items.
- Additional PipeTite™ products available from your nearest branch.



FLAT PIPETITE™ FLANGE

FLAT PIPETITE™ FLANGE

Flat PipeTite™ was designed for jacketed tank installations, although its applications are not limited to this. PipeTite™'s unique base design incorporates self-sealing ridges that provide excellent surface contact, so sealants are not required for installation. Superior flexibility allows the pipe to move significantly without breaking the seal.

0-95mm	Product Code:	S95PF
--------	---------------	-------

FEATURES:

- Constructed of hygienic white silicone and 316 stainless steel.
- Fits pipe and tubing up to 3" OD.
- Easily trimmed to size.
- Totally self-sealing – no sealant required.
- Predrilled for quick and easy installation with no messy clean-up.
- Flexible seal allows movement without damage or loss of seal.
- -4 - 260°C temperature rating.

PIPETITE™ POLY PANEL ANCHOR 316

PipeTite™ anchors are designed to provide a secure seal without additional bonding agents.

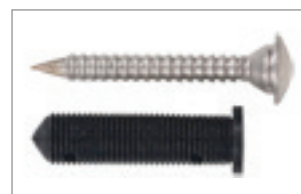

316 PIN & PLASTIC WALL PLUG (SPPA)

Product Code: SPPA



316 CONCRETE ANCHOR (SPCA)

Product Code: SPCA

VALVES



KLEANFLOW™ BUTTERFLY VALVE

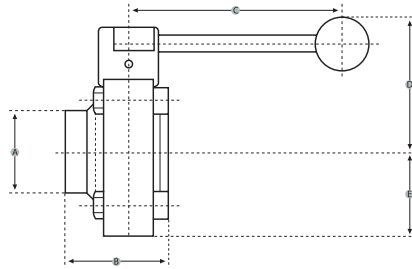

KLEANFLOW™ BUTTERFLY TUBE VALVE

SIZE / DIMENSIONS MM						304	316
INCH - A	MM - A	B	C	D	E		
1"	25.7	47.63	110	74	39	254BFSMPT*	254BFSMPT6*
1 1/2"	38.4	47.63	110	74	39	381BFSMPT*	381BFSMST6
2"	51.1	52.39	110	93	49.5	508BFSMPT*	508BFSMPT6
2 1/2"	63.8	53.98	110	83.5	58.5	635BFSMPT	635BFSMPT6
3"	76.5	61.91	159	98.5	66	762BFSMPT*	762BFSMPT6
4"	101.9	79.38	159	118	84.5	1016BFSMPT*	

- Butterfly tube valves have a 1,000 kPa pressure rating.
- Tube ball valves available on enquiry.

NON-RETURN TUBE VALVE

SIZE		NON-RETURN VALVE
INCH	OD MM	
3/4"	19.0	19SNRVO6
1"	25.4	254SNRVO6
1 1/2"	38.1	381SNRVO6
2"	50.8	508SNRVO6
2 1/2"	63.5	635SNRVO6



NON-RETURN VALVE



1 PIECE BALL VALVE

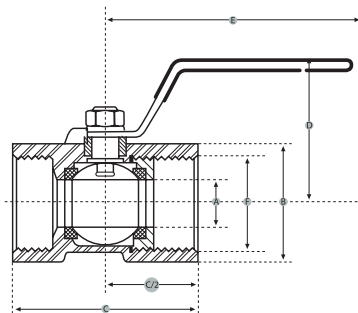

BSP 1 PIECE PIPE BALL VALVE

SIZE / DIMENSIONS MM						316
INCH	MM	A	C	D	E	
1/4"	8	5	39	33	68.5	8SB1*
3/8"	10	7	44	35	90	10SB1*
1/2"	15	9.2	57	40	98	15SB1*
3/4"	20	12.5	59	44	98	20SB1*
1"	25	15	71	51	111	25SB1*
1 1/4"	32	20	78	57	111	32SB1*
1 1/2"	40	25	83	64	139	40SB1*
2"	50	32	100	70	139	50SB1*

* Denotes normal stock items.

VALVES (CONTINUED)



2 PIECE BALL VALVE

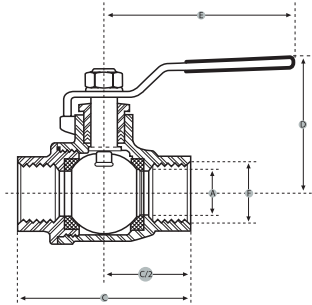

BSP 2 PIECE PIPE BALL VALVE

SIZE / DIMENSIONS MM						316
INCH	MM	A	C	D	E	
1/4"	8	12.5	51	45	103	8SB2*
3/8"	10	12.5	51	45	103	10SB2*
1/2"	15	15	63	46	103	15SB2*
3/4"	20	20	74	51	126	20SB2*
1"	25	25	86	65	144	25SB2*
1 1/4"	32	32	98	69	144	32SB2*
1 1/2"	40	38	106	85	189	40SB2*
2"	50	50	122	93	189	50SB2*



3 PIECE BALL VALVE

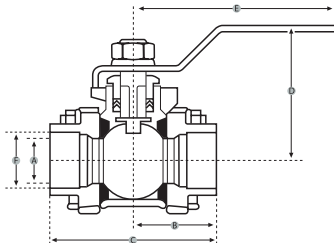

BSP 3 PIECE PIPE BALL VALVE

SIZE / DIMENSIONS MM						316
INCH	MM	A	C	D	E	
1/4"	8	12.5	72	48	105	8SB3*
3/8"	10	12.5	72	48	105	10SB3*
1/2"	15	15	72	50	105	15SB3*
3/4"	20	20	80	52	125	20SB3*
1"	25	25	85	65	144	25SB3*
1 1/4"	32	32	105	70	144	32SB3*
1 1/2"	40	38	113	85	189	40SB3*
2"	50	50	132	93	189	50SB3*
2 1/2"	65	65	170	116	224	65SB3*
3"	80	76	186	125	224	80SB3*
4"	100	94	220	180	251	100SB3*

* Denotes normal stock items.

VALVES (CONTINUED)



L-PORT BALL VALVE

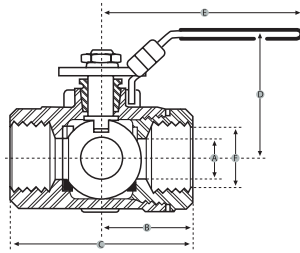

3 WAY L- AND T-PORT BALL VALVE

SIZE / DIMENSIONS MM					316 L-PORT	316 T-PORT
INCH	NB	A	C	D		
1/2"	15	12.7	75	68	15SSL	15SST*
3/4"	20	16	85	73	20SSL	20SST*
1"	25	20	100	83	25SSL	25SST*
1 1/2"	40	32	124	97	40SSL	40SST*
2"	50	38	147	106	50SSL	50SST*



GATE VALVE CLASS 200

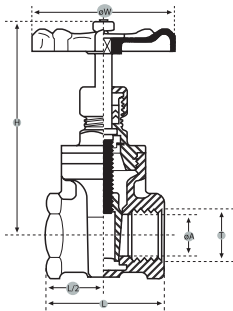

GLOBE VALVE CLASS 200

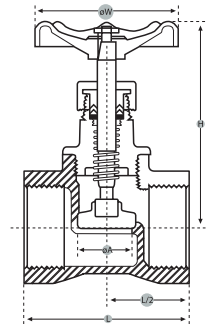

GATE VALVE

SIZE / DIMENSIONS MM					316
INCH	NB	LENGTH MM	HEIGHT MM	WIDTH MM	
1/2"	15	55	92	70	15SGA*
3/4"	20	60	99	70	20SGA*
1"	25	66	113	80	25SGA*
1 1/4"	32	76	128	80	32SGA
1 1/2"	40	86	147	100	40SGA*
2"	50	96	168	100	50SGA*

GLOBE VALVE

SIZE / DIMENSIONS MM					316
INCH	NB	LENGTH MM	HEIGHT MM	WIDTH MM	
1/2"	15	52	87	70	15SGL*
3/4"	20	60	90	70	20SGL*
1"	25	71	99	80	25SGL*
1 1/4"	32	82	118	80	32SGL*
1 1/2"	40	90	140	100	40SGL*
2"	50	101	155	100	50SGL*

* Denotes normal stock items.

STAINLESS SAMPLE VALVES & FITTINGS



TUBE BUTT WELD SIGHT GLASS

Product Code: (OD)SG



BSP LOCKABLE SAMPLE VALVE

Product Code: (NB)SSV



VINCENT SAMPLE NOZZLE

Product Code: (SZSN)
shown with Nitrile (food grade)
plug (SZSNP)

Note:

* Other sample valves are available by enquiry.

VALVES (CONTINUED)



SWING CHECK VALVE

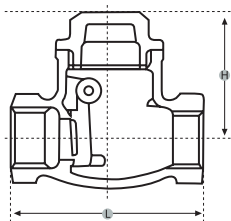

Y-STRAINER VALVE

SWING CHECK VALVE

SIZE / DIMENSIONS MM				316
INCH	NB	LENGTH MM	HEIGHT MM	
1/2"	15	65	43	15SSC*
3/4"	20	60	53	20SSC*
1"	25	90	60	25SSC*
1 1/4"	32	105	60	32SSC*
1 1/2"	40	120	75	40SSC*
2"	50	140	79	50SSC*

Y-STRAINER VALVE

SIZE / DIMENSIONS MM				316
INCH	NB	LENGTH MM	HEIGHT MM	
1/2"	15	65	35	15SSY*
3/4"	20	60	45	20SSY*
1"	25	90	57	25SSY*
1 1/4"	32	105	58	
1 1/2"	40	120	68	40SSY
2"	50	140	77	50SSY



Y-SPRING CHECK VALVE (HORIZONTAL)



SPRING CHECK VALVE (VERTICAL)

Y-SPRING CHECK VALVE

SIZE / DIMENSIONS MM				316
INCH	NB	LENGTH MM	HEIGHT MM	
1/2"	15	65	35	15SSPY*
3/4"	20	80	45	20SSPY*
1"	25	90	57	25SSPY
1 1/4"	32	105	58	32SSPY*
1 1/2"	40	120	66	40SSPY*
2"	50	140	77	50SSPY

VERTICAL SPRING CHECK VALVE

SIZE / DIMENSIONS MM				316
INCH	NB	LENGTH MM	WIDTH MM	
1/2"	15	69	65	15SSP*
3/4"	20	74	70	20SSP*
1"	25	80	79	25SSP*
1 1/4"	32	95	86	32SSP
1 1/2"	40	101	102	40SSP*
2"	50	114	118	50SSP

* Denotes normal stock items.

PERFORATED SHEET

PERFORATED 304 SHEET

CODE	THICKNESS MM	WIDTH MM	LENGTH MM	HOLE DIAMETER MM	OPEN AREA %	HOLE CENTRES MM	FINISH
S153PS*	1.5	1200	2400	3.00	32.6	5.00	2B
S15476PS	1.5	1200	2400	4.76	50.9	6.35	2B
S156PS*	1.5	1200	2400	6.00	40.0	9.00	2B
S158PS*	1.5	1200	2400	8.00	58.0	10.00	2B
S1510PS*	1.5	1200	2400	10.00	46.0	14.00	2B
S1520PS	1.5	1200	2400	20.00	63.0	24.00	2B

WALKWAY SHEET & PLANK PROFILES

These planks are punched and folded in New Zealand to meet the needs of industry where steps, walkways and ramps are required. Standard size is 300mm wide x 50mm deep with 25mm return. Available in 3 metre lengths. Custom sizes available upon request. 304 grade standard. 316 grade available upon request.

Product codes:

S21224WWS:

WALKWAY SHT 2.0mm x 1200mm x 2400mm 304

15mm Dia Dimple x 6.35mm Dia Hole

S2123WWS:

WALKWAY SHT 2.0mm x 1200mm x 3000mm 304

15mm Dia Dimple x 6.35mm Dia Hole

S2WWP:

WALKWAY PLANK 2.0mm x 25mm x 50mm x 300mm 304

6.35mm Dia Hole, 3000mm long

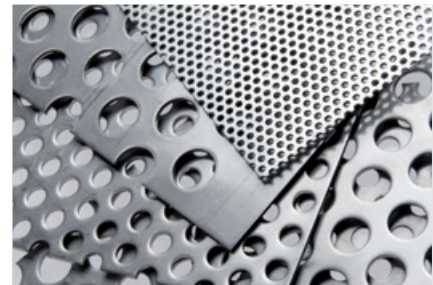

PERFORATED SHEET

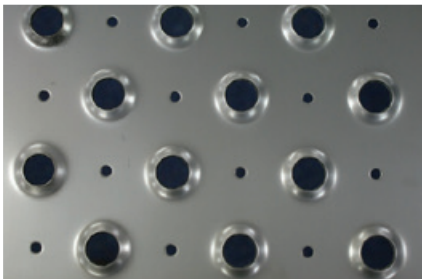

WALKWAY SHEET

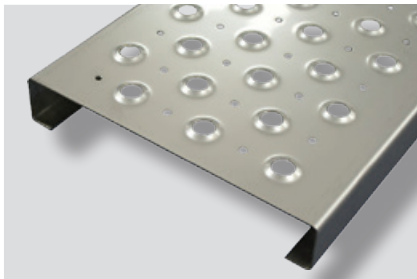

WALKWAY PLANK

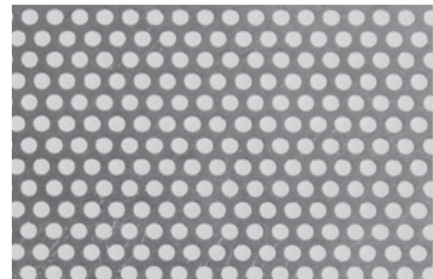

3MM DIAMETER SHEET



6MM DIAMETER SHEET



8MM DIAMETER SHEET



10MM DIAMETER SHEET

* Denotes normal stock items, other sizes and grades are available by request only.

Notes:

- Additional services: Individually custom designed perforations and patterns can be supplied.
- Perforations also available in No.4 and mirror finish upon request.
- Lead times may apply.

STAINLESS STEEL STANDARD MESH



1

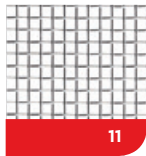

11



2

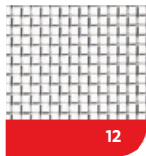

12

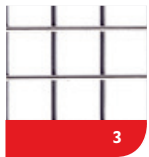

3

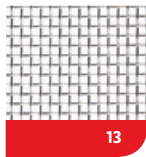

13



4

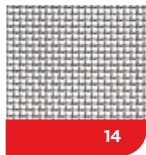

14



5

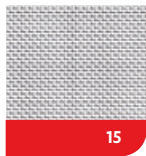

15

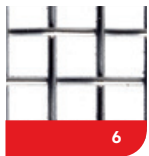

6

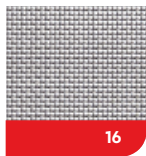

16

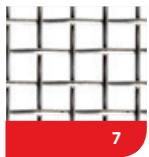

7

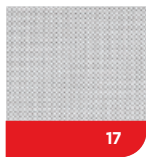

17

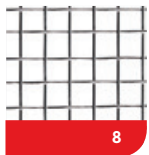

8

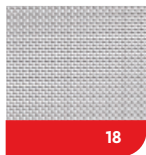

18

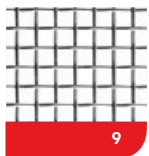

9



19

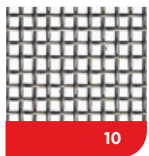

10

WELDED MESH

PIC#	SQUARES PER INCH	APERTURE MM	WIRE DIAMETER MM	WEIGHT KG/M ²	304
1	1 x 1	23.4	1.6	1.25	S116M*
2	2 x 2	11.1	1.6	2.53	S216M*
3	4 x 4	5.55	0.8	1.25	S48M*

WOVEN MESH

PIC#	SQUARES PER INCH	APERTURE MM	WIRE DIAMETER MM	WEIGHT KG/M ²	304
4	2 x 2	11.1	1.6	2.53	S21625M*
5	4 x 4	4.75	1.6	5.07	S41625M*
6	4 x 4	5.15	1.2	2.73	S41219M*
7	6 x 6	3.43	0.8	1.85	S6812M*
8	8 x 8	2.72	0.45	0.79	S8457M
9	10 x 10	2.04	0.5	1.23	S10503M*
10	14 x 14	1.24	0.57	2.2	S1457M*
11	16 x 16	1.29	0.29	0.66	S16294M*
12	20 x 20	0.98	0.29	0.83	S20294M*
13	24 x 24	0.77	0.77	1.26	S24294M
14	30 x 30	0.55	0.29	1.24	S30294M*
15	40 x 40	0.4	0.23	1.03	S40233M
16	50 x 50	0.31	0.19	0.9	S50193M*
17	60 x 60	0.23	0.19	1.1	S60193M*
18	80 x 80	0.19	0.12	0.55	S801219M*
19	100 x 100	0.15	0.1	0.47	S1001016M*

* Denotes normal stock items.

Notes:

- Other sizes and grades (316) are available upon request only.
- All standard mesh supplied in roll-form – 1m x 30m.
- Sold cut-to-length.
- New Item: S146M will replace S1457M.

STAINLESS STEEL DESIGNER MESH

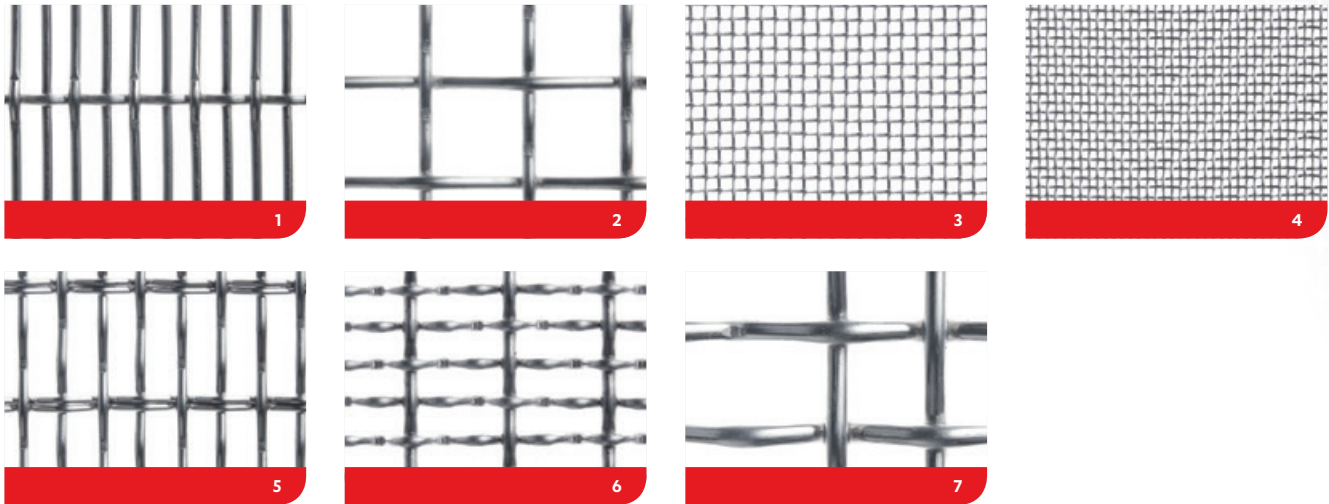

PIC#	MESH TYPE	APERTURE MM	WIRE DIAMETER MM	OPEN AREA %	WEIGHT KG/M ²	SHEET SIZE	316
1	Mono Weave	2.5 x 30	2	52	6.60	2500 x 1200	SMWM6*
2	Mono Square	12.5 x 12.5	2.5	69	5.30	2500 x 1200	SMSM6
3	Protecta	1.4 x 1.4	0.71	44	3.20	2500 x 1200	SPRM6*
4	Herringbone	0.71 x 0.9	0.56	34	3.00	2500 x 1200	SHWM6
5	Duo Weave	4 x 15	2.0/2 x 1.25	57	5.60	2500 x 1200	SDWM6
6	Uno Weave	12.5 x 3.55	2.5/2.0	53	7.40	2500 x 1200	SUWM6*
7	Duo Robusto	11.2 x 150	4.0/ 2 x 4.0	70	8.50	2500 x 1200	SDRM6*

* Denotes stock holding at the date of publication, other sizes are available upon request – minimum order quantities may apply.

STAINLESS ARCHITECTURAL SHEET

EMBOSSED SHEET

DESCRIPTION	SHEET SIZE MM	THICKNESS MM	304
DOTS LUCID	2500 x 1250	0.8	SAS8DL
LINO LUCID	2500 x 1250	0.8	SAS8LLS
PELLE	2500 x 1250	0.8	SAS8PL
AUSTENIT	2500 x 1250	0.8	SAS8AP
LINO SATIN	3000 x 1000	1.2	SAS1210003LS
DOTS LUCID	3000 x 1250	1.2	SAS1212503DL
LINO LUCID	3000 x 1000	1.2	SAS1213LL
LINO LUCID	3600 x 1000	1.2	SAS12136LL
DOTS LUCID	4000 x 1250	1.2	SAS1212504DL
LINO LUCID	3000 x 1250	1.2	SAS1212503LL

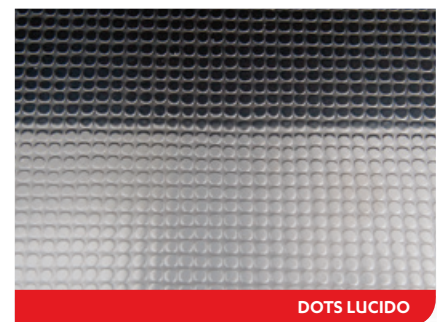

RIGIDISED SHEET

DESCRIPTION	SHEET SIZE MM	THICKNESS MM	304
DIMPLED - 6WL	2500 x 1250	1.5	SAS156W*
DIMPLED - 5WL	1800 x 1200	0.6	SAS61250185W*
DIMPLED - 2WL	2500 x 1250	0.6	SAS62W*
STRIPES	2500 x 1250	0.6	SAS6ST*



* Denotes stock holding at the date of publication, other sizes, profiles and colours are available upon request.

A-JUSTA-FOOT

The A-Justa-Foot is a multi-adjustable pedestal foot, ideal for industrial, commercial, workshop or food industry applications.

The special insert in the base helps to absorb vibration and means your machinery will stay exactly where you put it.

A heavy duty stainless steel option is also available - ideal for chemical and food industry applications, and for very heavy machinery.

An anti-vibration pad is also available as an optional extra.

A-JUSTA-FOOT

DIAMETER MM	LENGTH MM	STUD / THREAD DIAMETER	BLACK NYLON FOOT / 304 THREAD
40	80	M10	SAF4080M10*
40	100	M8	SAF40100M8*
60	100	M12	SAF60100M12*
60	100	M16	SAF60100*
60	200	M16	SAF60200*
90	100	M12	SAF90100M12*
90	100	M16	SAF90100*
90	100	M20	SAF90100M20*
90	120	M20	SAF90120M20*
90	200	M16	SAF90200*
90	200	M20	SAF90200M20*
90	300	M20	SAF90300M20*



BOLTA-FOOT

DIAMETER MM	LENGTH MM	STUD / THREAD DIAMETER	BLACK NYLON FOOT / 304 THREAD
60	100	M12	SAFB60100M12*
60	100	M16	SAFB60100*
60	200	M16	SAFB60200*
90	100	M12	SAFB90100M12*
90	100	M16	SAFB90100*
90	200	M16	SAFB90200*



FIXED A-JUSTA-FOOT (MILD STEEL)

DIAMETER MM	LENGTH MM	STUD / THREAD DIAMETER	304
40	60	M10	SAFF4060*
60	60	M12	SAFF6060*



HEAVY DUTY STAINLESS A-JUSTA-FOOT

DIAMETER MM	LENGTH MM	STUD / THREAD DIAMETER	304
60	90	M12	SAFHD6090M12*
60	90	M20	SAFHD6090M20*
60	100	M16	SAFHDS60100*
90	90	M20	SAFHD9090M20*
90	100	M12	SAFHD90100M12*
90	100	M16	SAFHDS90100*
90	190	M16	SAFHD90190*
90	200	M16	SAFHDS90200*



* Denotes normal stock items.

HEAVY DUTY BOLT DOWN

New to our range is the HDA Stainless 304 Heavy Duty Bolt down A-Justa-Foot available in a 90 or 125mm base. All complete with the anti-slip pad, in stud sizes M16, M20 and M24.



HANDRAIL TUBE AND FITTINGS

HANDRAIL TUBE

OD MM	WALL THICKNESS MM	SATIN (320 GRIT)		SUPERBRIGHT (600 GRIT)	
		304	316	304	316
12.7	1.2	S12712TS*			S12715TM6
15.9	1.2			S15912TM	
15.9	1.5	S15915TS*			S15916TM6*
19.1	0.9	S199TS*			
19.1	1.2	S1912TS*		S1912TM*	S1912TM6*
19.1	1.5	S1915TS*	S1915TS6*	S1915TM*	S1915TM6*
22.2	1.2	S22212TS*			S22212TM6*
22.2	1.5	S22215TS*		S22215TM*	S22215TM6*
25.4	0.9	S2549TS			
25.4	1.2	S25412TS*			S25412TM6*
25.4	1.5	S25415TS*	S25415TS6*	S25415TM*	S25415TM6*
31.8	1.5	S31815TS*	S31815TS6*	S31815TM*	S31815TM6*
38.1	1.2	S38112TM			
38.1	1.5	S38115TS*	S38115TS6*	S38115TM*	S38115TM6*
38.1	3.0			S3813TM*	S3813TM6*
40.0	1.2				S4012TM6*
44.5	1.2	S44512TS			S44512TM6*
44.5	1.5	S44515TS*	S44515TS6*	S44515TM*	S44515TM6*
50.8	1.5	S50815TS*	S50815TS6*	S50815TM*	S50815TM6*
50.8	2.0				S5082TM6*
50.8	3.0	S5083TS*		S5083TM*	S5083TM6*
63.5	1.5	S63515TS*	S63515TS6*		S63515TM6
76.2	1.5	S76215TS*	S76215TS6*	S76215TM*	S76215TM6*
88.9	1.5	S88915TS			
101.6	1.5	S101615TS*	S101615TS6*		S101615TM6
127.0	1.5		S12715TS6		



HANDRAIL TUBE

ORNAMENTAL HANDRAIL TUBE

OD MM	WALL THICKNESS MM	304	316
RECTANGULAR PRO-IMAGE TUBE		SATIN	MIRROR
10 x 40	1.50		SATR1040M6
10 x 50	1.50		SATR1050M6
10 x 75	1.50		SATR1075M6*
10 x 40	1.50	SATR1040S*	
10 x 40	1.50	SATR1040S6	
10 x 50	1.50	SATR1050S6	
RIGIDISED TUBE		304	316
31.8	1.20	SATRIGI*	



PRO-IMAGE HANDRAIL TUBE



RIGIDISED HANDRAIL TUBE

* Denotes stock holding at the date of publication, other sizes are available upon request.

Note:

- A range of 316 stainless steel handrail fittings are available in selected sizes as shown over, please refer to our *Stainless Steel & Glass Handrail Systems* brochure and enquire with your nearest branch for more details.

HANDRAIL TUBE AND FITTINGS (CONTINUED)

To reference our full range of handrail fittings please see our *Stainless & Glass Handrail Systems* brochure for more details and enquire with your nearest Steel & Tube branch.



90° FLUSH JOINER

Example product: S1002E (FLUSH JOINER 90 DEG 25.4MM)

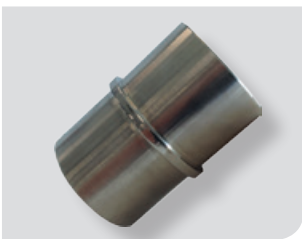

IN-LINE FLUSH JOINER

Example product: S2004E (FLUSH IN-LINE JOINER 50.8MM)

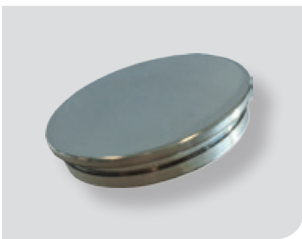

FLAT END CAP

Example product: S1519A (FLAT END CAP PUSH FIT 38.1MM)



POST REDUCER

Example product: S2022A (POST REDUCER 50.8MM FLAT)



RADIUSED HANDRAIL SUPPORT

Example product: S2028A (HANDRAIL SUPPORT BRACKET 38.1MM)

HANDRAIL TUBE AND FITTINGS (CONTINUED)

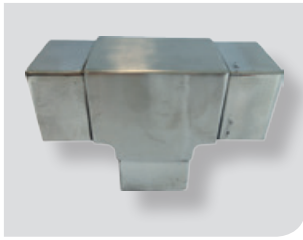

SQUARE JOINER TEE

Example product: SST2005 (SQUARE JOINER TEE 50.8MM)

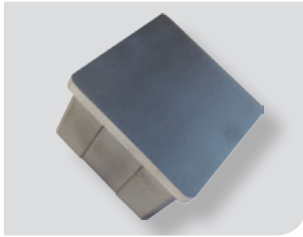

SQUARE FLAT END CAP

Example product: SST2019 (SQUARE FLAT END CAP 50.8MM)

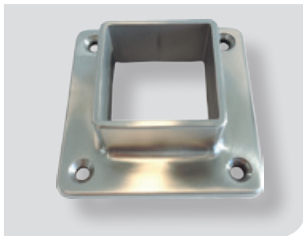

BASE PLATE / FLANGE

Example product: SST2016 (SQUARE BASE PLATE 50.8MM)



ROUND ADJUSTABLE SQUARE POST REDUCER

Example product: SST2021 (SQUARE POST REDUCER ADJUST 50.8MM)



SQUARE WALL STOP

Example product: SST2015 (SQUARE WALL STOP 50.8MM)



SQUARE POST REDUCER

Example product: SST2020 (SQUARE POST REDUCER 50.8MM)

Note:

- To reference our full range of handrail fittings please see our *Stainless & Glass Handrail Systems* brochure for more details and enquire with your nearest Steel & Tube branch.

HANDRAIL TUBE AND FITTINGS (CONTINUED)



HEAVY DUTY RADIUSED HANDRAIL SUPPORT WITHOUT TOP

Example product: SHBSB (70MM DIA X 5MM PLATE BASE)



ROUND BACK 'D' TYPE GLASS CLAMP – SATIN & MIRROR

Example product: SGS2104S (GLASS CLAMP D RND - SATIN)

6MM, 8MM, 10MM gaskets and pin included



FLAT BACK 'D' TYPE GLASS CLAMP – SATIN & MIRROR

Example product: SGSF2102M (GLASS CLAMP D FLAT – MIRROR)

6MM & 8MM gaskets and pin included



SQUARE FLAT BACK GLASS CLAMP – SATIN & MIRROR

Example product: SMGC200 (GLASS CLAMP FLAT SQ LARGE MIRROR)



Notes:

- Stainless steel wire rope and associated fittings and services are available, through your nearest Steel & Tube branch or please refer to our *Chain & Rigging Product Catalogue* published on our website: www.steelandtube.co.nz.
- To reference our full range of handrail fittings, please visit our website and see our *Stainless & Glass Handrail Systems* brochure for more details and enquire with your nearest Steel & Tube branch.

FASTENERS, CHAIN & RIGGING AND INDUSTRIAL PRODUCTS

Steel & Tube carry an extensive range of fasteners, chain & rigging and industrial products, including:



HINGES, LATCHES AND TOGGLES



SCREWS, BOLTS



GREASE NIPPLES, WASHERS, TENSION PINS

STAINLESS STEEL CHAIN

SIZE MM	T316 (DIN 763)
12.0 x 1.5	*
22.0 x 2.0	*
26.0 x 3.0	*
32.0 x 4.0	*
35.0 x 5.0	*
42.0 x 6.0	*
52.0 x 8.0	*
65.0 x 10.0	*

* Denotes normal stock items.



CIRCLIPS



NUTS AND WASHERS



THREADED ROD



RIVETS AND SPLIT PINS

Threaded rod sizes:
316: 3m to 30m
304: 3m to 24m

Sleeve anchors, key steel and nails also available (not pictured).



SHACKLE



PIPE CLAMP

CHAIN & RIGGING

- Chain
- Shackles
- Turnbuckles
- Wire rope
- Wire rope fittings

INDUSTRIAL

- Pipe clamps
- Food grade lubricants

PIPE TECHNICAL DATA

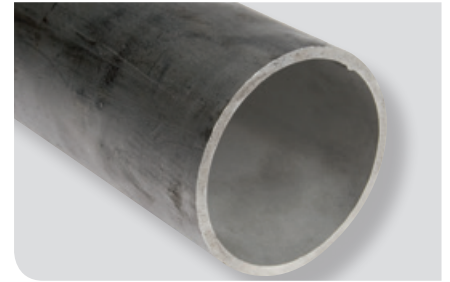

THEORETICAL BURSTING PRESSURES OF STAINLESS STEEL PIPE MATERIAL TO ASTM A312

STEEL PIPE METRIC CONVERSION						THEORETICAL BURSTING PRESSURES					
NOMINAL BORE MM	NOMINAL BORE INCH	OD MM	SCHEDULE 10S			SCHEDULE 40S			SCHEDULE 80S		
			WALL MM	WEIGHT KG/M	PRESSURE KPA*	WALL MM	WEIGHT KG/M	PRESSURE KPA*	WALL MM	WEIGHT KG/M	PRESSURE KPA
6	1/8"	10.29	1.24	0.28	125139	1.73	0.37	173575	2.41	0.47	242523
8	1/4"	13.72	1.65	0.49	124450	2.24	0.63	168576	3.02	0.80	227871
10	3/8"	17.15	1.65	0.63	99629	2.31	0.84	139446	3.20	1.10	193053
15	1/2"	21.34	2.11	1.00	102214	2.77	1.27	134275	3.73	1.62	180987
20	3/4"	26.67	2.11	1.28	81702	2.87	1.69	111350	3.91	2.20	151684
25	1"	33.40	2.77	2.09	85839	3.38	2.50	104628	4.55	3.24	140825
32	1 1/4"	42.16	2.77	2.70	67913	3.56	3.39	87218	4.85	4.47	118934
40	1 1/2"	48.26	2.77	3.11	59295	3.68	4.05	78945	5.08	5.41	108937
50	2"	60.33	2.77	3.93	47401	3.91	5.44	67224	5.54	7.48	94975
65	2 1/2"	73.03	3.05	5.26	43092	5.16	8.63	73084	7.01	11.41	99284
80	3"	88.90	3.05	6.45	35508	5.49	11.29	63776	7.62	15.27	88646
100	4"	114.3	3.05	8.36	27579	6.02	16.07	54468	8.56	22.32	77452
125	5"	141.3	3.40	11.57	24993	6.55	21.77	47918	9.52	30.97	69678
150	6"	168.28	3.40	13.84	21029	7.11	28.26	43782	10.97	42.6	67418
200	8"	219.08	3.76	19.96	17754	8.18	42.55	38610	12.70	64.6	59974
250	10"	273.05	4.19	27.80	15857	9.27	60.30	35163	12.70	96.01	48102
300	12"	323.85	4.57	36.00	14651	9.53	73.88	30337	12.70	132.08	40557
350	14"	355.6	4.78	41.30	13967	*Theoretical internal bursting pressure calculated using formula; $P=2St/OD$					
400	16"	406.4	4.78	47.29	12238						
450	18"	457.2	4.78	53.26	10859						
500	20"	508	5.54	68.61	11204						

* Nominal bursting, test and working pressures for stainless steel pipe (based on Barlow's formula).

* Bursting pressure rating: (ref ASTM A230M) $P = (2 \times S \times t) / OD$.

* P = Bursting pressure in MPa (x 1000 to get kPa).

* t = wall thickness (mm).

* OD = Outside diameter (mm).

* S = Minimum ultimate tensile strength in MPa.

* Test pressure:

substitute: s = 50-60% of minimum material 0.2% yield stress MPa.

Note:

- Weights are approximate.

TECHNICAL DATA > BUTT WELD FITTINGS

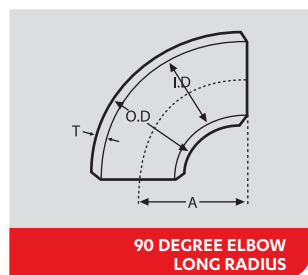

90 DEGREE ELBOW
LONG RADIUS

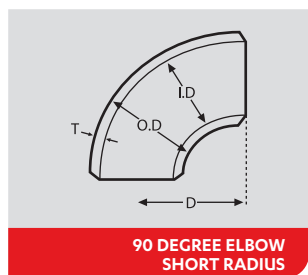

90 DEGREE ELBOW
SHORT RADIUS

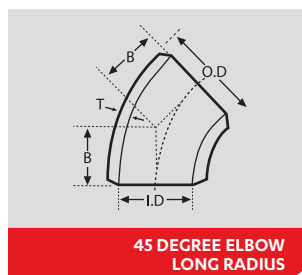

45 DEGREE ELBOW
LONG RADIUS

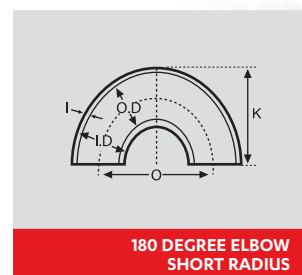

180 DEGREE ELBOW
SHORT RADIUS

ELBOW

MADE TO ANSI B16.9 AND ASTM A403 SPECIFICATIONS

NOMINAL PIPE SIZE		OUTSIDE DIAMETER OD MM	CENTRE TO FACE [A] MM	CENTRE TO FACE [D] MM	CENTRE TO FACE [B] MM	BACK TO FACE [K] MM
MM	INCH					
15	0.5	21.34	38.10	25.4	15.88	47.63
20	0.75	26.67	28.58	19.05	11.11	42.86
25	1	33.40	38.10	25.40	22.23	55.56
32	1.25	42.16	47.63	31.75	25.40	69.85
40	1.5	48.26	57.15	38.10	28.58	82.55
50	2	60.33	76.20	50.80	34.93	106.36
65	2.5	73.03	95.25	63.50	44.45	131.76
80	3	88.90	114.30	76.20	50.80	158.75
90	3.5	101.60	133.35	88.90	57.15	184.15
100	4	114.30	152.40	101.60	63.50	209.55
125	5	141.30	190.50	127.00	79.38	261.94
150	6	168.28	228.60	152.40	95.25	312.74
200	8	219.08	304.80	203.20	127.00	414.34
250	10	273.05	381.00	254.00	158.75	517.53
300	12	323.85	457.20	304.80	190.50	619.13
350	14	355.60	533.40	355.60	222.25	740.68
400	16	406.40	609.60	406.40	254.00	886.09
450	18	457.20	685.80	457.20	285.75	1060.04
500	20	568.00	762.00	508.00	317.50	1268.04
600	24	609.60	914.40	609.60	381.00	1814.80

TECHNICAL DATA > BUTT WELD FITTINGS (CONTINUED)

STRAIGHT TEE, CAP AND STRAIGHT CROSS

MADE TO ANSI B16.9 AND ASTM A403 SPECIFICATIONS

NOMINAL PIPE SIZE		OUTSIDE DIAMETER OD MM	CENTRE TO END [C] MM	LENGTH [E] MM	CENTRE TO END [C] MM
MM	INCH				
15	0.5	21.34	25.40	25.40	25.40
20	0.75	26.67	28.58	25.40	25.40
25	1	33.44	38.10	38.10	38.10
32	1.25	42.16	47.63	38.10	47.63
40	1.5	48.26	57.15	38.10	57.15
50	2	60.33	63.50	38.10	63.50
65	2.5	73.03	76.20	38.10	78.20
80	3	88.90	85.73	50.80	85.73
90	3.5	101.60	95.25	63.50	95.25
100	4	114.30	104.78	63.50	104.78
125	5	141.30	123.83	76.20	123.83
150	6	168.28	142.88	88.90	142.88
200	8	219.08	177.81	101.64	177.80
250	10	273.05	215.90	127.00	215.90
300	12	323.85	254.00	152.40	254.00
350	14	355.60	279.40	165.10	279.40
400	16	406.40	304.80	177.80	304.80
450	18	457.20	342.90	203.20	342.90
500	20	508.00	381.00	228.60	381.00
600	24	609.60	431.80	266.70	431.80

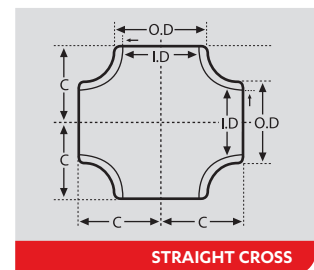
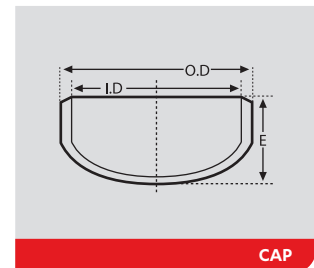
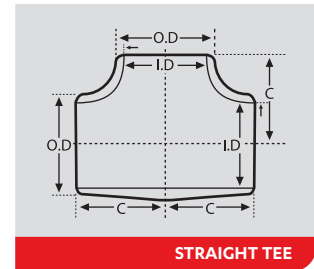

STUB END

MADE TO ANSI B16.9 AND ASTM A403 SPECIFICATIONS

NOMINAL PIPE SIZE		OUTSIDE DIAMETER OD MM	DIAMETER [G] MM	LENGTH [F] MM	RADIUS [R] MM
MM	INCH				
15	0.5	21.34	35.05	50.80	3.05
20	0.75	26.67	42.93	50.80	3.05
25	1	33.40	50.80	50.80	3.05
32	1.25	42.16	63.50	50.80	4.83
40	1.5	48.26	73.15	50.80	6.35
50	2	60.33	91.95	63.50	7.87
65	2.5	73.03	104.65	63.50	7.87
80	3	88.90	127.00	63.50	9.65
90	3.5	101.60	139.70	76.20	9.65
100	4	114.30	157.23	76.20	11.18
125	5	141.30	185.67	76.20	11.18
150	6	168.28	215.90	88.90	12.70
200	8	219.08	269.75	101.60	12.70
250	10	273.05	323.85	127.00	12.70
300	12	323.85	381.00	152.40	12.70
350	14	355.60	412.75	152.40	12.70
400	16	406.40	469.90	152.40	12.70
450	18	457.20	533.40	152.40	12.70
500	20	568.00	584.20	152.40	12.70

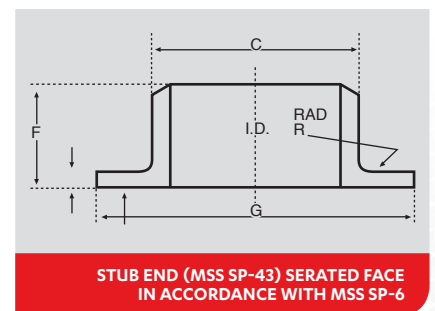

TECHNICAL DATA > BSP THREADED CLASS 150 FITTINGS

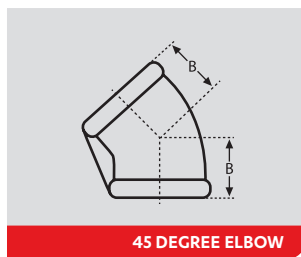
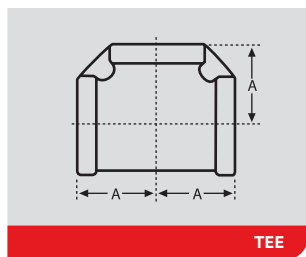
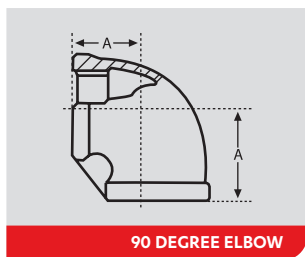

BSP ELBOW AND TEE

MADE TO BS21 AND ASTM A312 SPECIFICATIONS

NOMINAL PIPE SIZE		90 DEGREE ELBOW	TEE	45 DEGREE ELBOW
MM	INCH	A MM	A MM	B MM
6	0.125	21	21	18
8	0.25	21	21	18
10	0.375	24	24	20
15	0.5	28	28	22
20	0.75	33	33	25
25	1	38	38	28
32	1.25	44	34	33
40	1.5	49	49	36
50	2	57	57	43
65	2.5	69	69	50
80	3	78	78	55
100	4	96	96	66

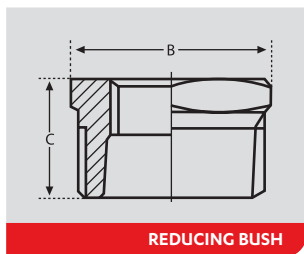
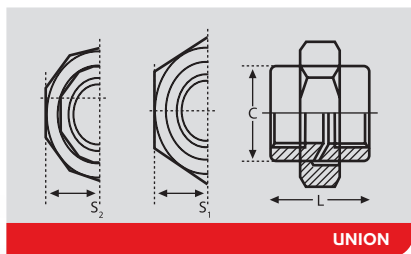

BSP UNION AND REDUCING BUSH

MADE TO BS21 AND ASTM A312 SPECIFICATIONS

NOMINAL PIPE SIZE		UNION				REDUCING BUSH		
MM	INCH	C MM	L MM	S1 [HEX] MM	S2 [HEX] MM	B MM	C MM	REDUCING SIZE NB
6	0.125	17	30	26				
8	0.25	20	34	32				6
10	0.375	25	37	38		19	18	8
15	0.5	29	40	41		23	21	10 + 8
20	0.75	36	43	50		29	24	15 + 10 + 8
25	1	41	51	59	59	35	27	20 + 15 + 10 + 8
32	1.25	50	55		69	46	30	25 + 20 + 15
40	1.5	49	56	59		78	50	32 + 25 + 20 + 15
50	2	69	66		93	63	36	40 + 32 + 25 + 20
65	2.5	86	83		112	80	39	50 + 40 + 32 + 25
80	3	99	92		127	95	44	65 + 50 + 40 + 32
100	4	127	113		158	120	51	80 + 65 + 50 + 40

TECHNICAL DATA › BSP THREADED CLASS 150 FITTINGS (CONTINUED)

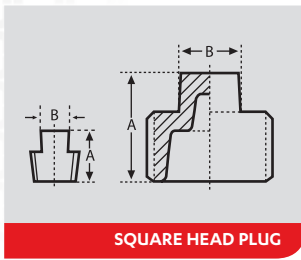

SQUARE HEAD PLUG

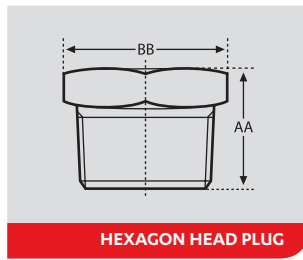

HEXAGON HEAD PLUG

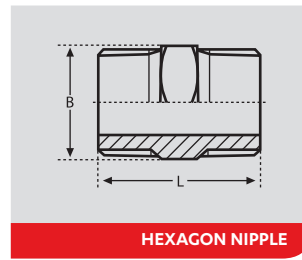

HEXAGON NIPPLE

BSP SQUARE HEAD PLUG, HEX HEAD PLUG AND NIPPLE

MADE TO BS21 AND ASTM A312 SPECIFICATIONS

NOMINAL PIPE SIZE		SQUARE HEAD PLUG		HEXAGON HEAD PLUG		HEXAGON NIPPLE	
MM	INCH	B MM	A MM	BB MM	AA MM	B MM	L MM
8	0.25	9	18	14	19	14	34
10	0.375	12	21	19	22	19	36
15	0.5	14	25	23	24	23	42
20	0.75	17	27	29	27	29	47
25	1	19	32	35	30	35	52
32	1.25	23	35	46	34	46	56
40	1.5	26	37	50	37	50	60
50	2	32	41	63	41	63	66
65	2.5	41	48			80	73
80	3	46	51			95	81
100	4	58	58			120	92

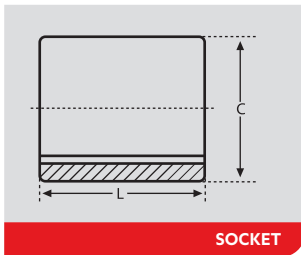

SOCKET

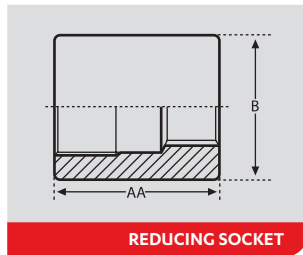

REDUCING SOCKET

BSP SOCKET

MADE TO BS21 AND ASTM A312 SPECIFICATIONS

NOMINAL PIPE SIZE		SOCKET		REDUCING SOCKET	
MM	INCH	C MM	L MM	B MM	AA MM
8	0.25	17	25	19	29
10	0.375	21	26	22	30
15	0.5	25	34	27	38
20	0.75	31	36	33	40
25	1	38	43	40	45
32	1.25	47	48	49	51
40	1.5	54	48	56	54
50	2	66	56	68	64

TECHNICAL DATA › BSP THREADED CLASS 150 FITTINGS (CONTINUED)

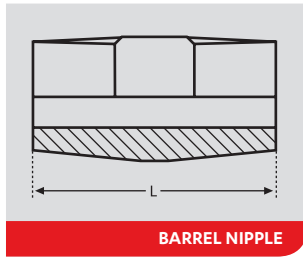

BARREL NIPPLE

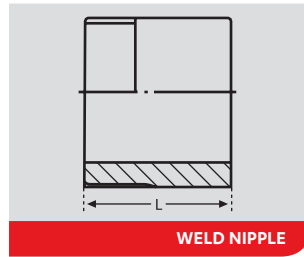

WELD NIPPLE

BSP BARREL AND WELD NIPPLE

MADE TO BS21 AND ASTM A312 SPECIFICATIONS

NOMINAL PIPE SIZE		BARREL NIPPLE	WELD NIPPLE
MM	INCH	L MM	L MM
6	0.125	20	20
8	0.25	26	26
10	0.375	28	28
15	0.5	34	34
20	0.75	38	38
25	1	44	44
32	1.25	50	50
40	1.5	50	50
50	2	58	58
65	2.5	70	70
80	3	78	78
100	4	90	90

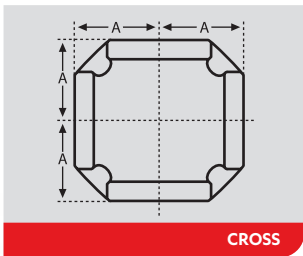

CROSS

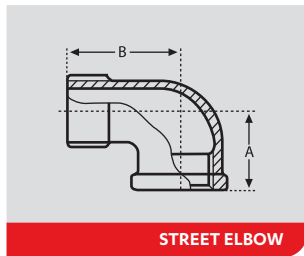

STREET ELBOW

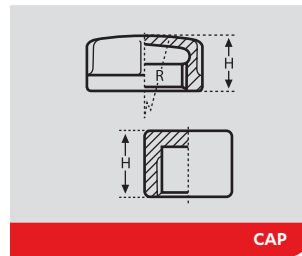

CAP

BSP CROSS, STREET ELBOW AND CAP

MADE TO BS21 AND ASTM A312 SPECIFICATIONS

NOMINAL PIPE SIZE		CROSS	STREET ELBOW		CAP	
MM	INCH	A MM	A MM	B MM	H MM	R MM
8	0.25	21	21	35	18	
10	0.375	24	24	37	19	
15	0.5	28	28	41	22	
20	0.75	33	33	48	25	
25	1	38	38	54	29	
32	1.25	49	49	68	32	150
40	1.5	49	49	68	32	170
50	2	57	57	83	36	215
65	2.5				42	269
80	3				45	310
100	4				55	404

TECHNICAL DATA > BSP THREADED CLASS 150 FITTINGS (CONTINUED)

BSP REDUCING NIPPLE

MADE TO BS21 AND ASTM A312 SPECIFICATIONS

NOMINAL PIPE SIZE		REDUCING NIPPLE				
MM	INCHES	E ₁ MM	E ₂ MM	E ₂ MM	E ₂ MM	REDUCING SIZE MM
8	0.25	12	10			0.125
10	0.375	13	12			0.25
15	0.5	16	13	12		0.375 * 0.25
20	0.75	18	16	13		0.5 * 0.375
25	1	20	18	16	13	0.75 * 0.5 * 0.375
32	1.25	22	20	18	16	1 * 0.75 * 0.5
40	1.5	23	22	20	18	1.25 * 1 * 0.75
50	2	25	23	22	20	1.5 * 1.25 * 1

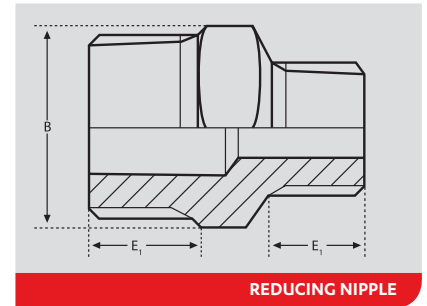

BRITISH STANDARD THREAD (BSP)

NOMINAL PIPE SIZE		OUTSIDE DIAMETER OF S/S PIPE	NUMBER OF THREADS PER INCH	PITCH	DEPTH OF THREAD	DIAMETER AT GAUGE PLANE (GAUGE DIA.)	DISTANCE OF GAUGE DIAMETER (GAUGE LENGTH)	LENGTH OF USEFUL THREAD
MM	INCHES	D MM			H	E	L ₁	L ₂
6	0.125	0.405	28	0.03571	0.0229	0.383	0.1563	0.2545
8	0.25	0.540	19	0.05263	0.0337	0.518	0.2367	0.3314
10	0.375	0.675	19	0.05263	0.0337	0.656	0.2500	0.3940
15	0.5	0.840	14	0.07143	0.0457	0.825	0.3214	0.5178
20	0.75	1.050	14	0.07143	0.0457	1.041	0.3750	0.5714
25	1	1.315	11	0.09091	0.0582	1.309	0.4091	0.6591
32	1.25	1.660	11	0.09091	0.0582	1.650	0.5000	0.7500
40	1.5	1.900	11	0.09091	0.0582	1.882	0.5000	0.7500
50	2	2.375	11	0.09091	0.0582	2.347	0.6250	0.9204
65	2.5	2.875	11	0.09091	0.0582	2.950	0.6875	1.0511
80	3	3.500	11	0.09091	0.0582	3.450	0.8125	1.1761
100	4	4.500	11	0.09091	0.0582	4.450	1.0000	1.4091
125	5	5.563	11	0.09091	0.0582	5.450	1.1250	1.5795
150	6	6.625	11	0.09091	0.0582	6.450	1.1250	1.5795

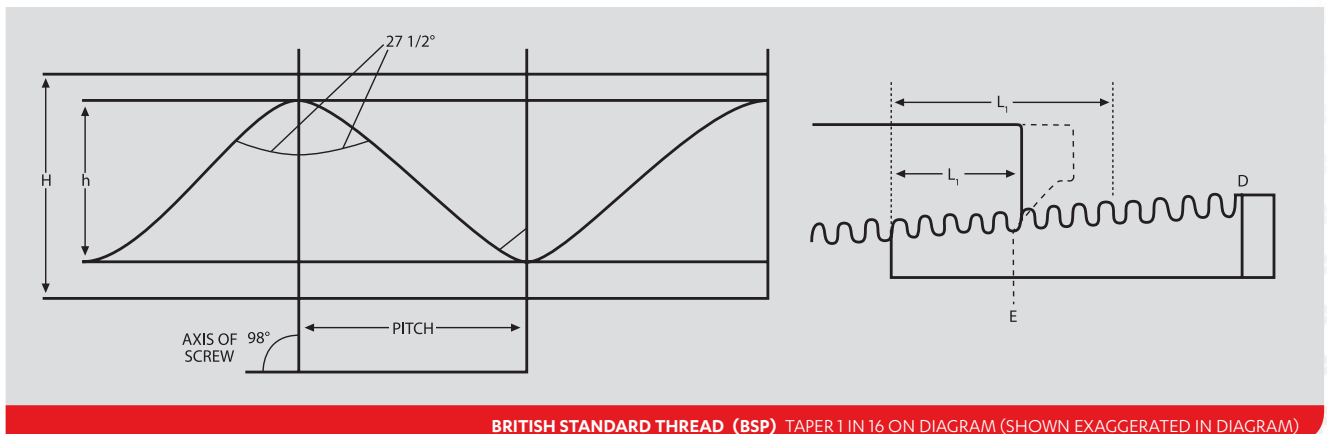

Note:

TAPER: $H = 0.960237xp$
 $h = 0.610327xp$
 $r = 0.127278xp$

TECHNICAL DATA › NPT DIMENSIONS OF PIPE THREADS

AMERICAN STANDARD THREAD

NOMINAL PIPE SIZE		OUTSIDE DIAMETER OF S/S PIPE	NUMBER OF THREADS PER INCH	PITCH	HAND-TIGHT	EFFECTIVE ENGAGEMENT EXTERNAL	THREAD LENGTH	DEPTH
MM	INCHES	D	N	P	L1	E1	L2	H
6	0.125	0.405	27	0.03704	0.180	0.37476	0.2639	0.02963
8	0.25	0.540	18	0.05556	0.200	0.48989	0.4018	0.04444
10	0.375	0.675	18	0.05556	0.240	0.62701	0.4078	0.04444
15	0.5	0.840	14	0.07143	0.320	0.77843	0.5337	0.05714
20	0.75	1.050	14	0.07143	0.339	0.98887	0.5457	0.05714
25	1	1.315	11.5	0.08696	0.400	1.23863	0.6828	0.06957
32	1.25	1.660	11.5	0.08696	0.420	1.56338	0.7068	0.06957
40	1.5	1.900	11.5	0.08696	0.420	1.82234	0.7235	0.06957
50	2	2.375	11.5	0.08696	0.436	2.29627	0.7665	0.06957
65	2.5	2.875	8	0.12500	0.682	2.76216	1.1375	0.10000
80	3	3.500	8	0.12500	0.766	3.8850	1.2000	0.10000
90	3.5	4.000	8	0.12500	0.821	3.88881	1.2500	0.10000
100	4	4.500	8	0.12500	0.844	4.38712	1.3000	0.10000
125	5	5.563	8	0.12500	0.937	5.44929	1.4063	0.10000
150	6	6.625	8	0.12500	0.958	6.50597	1.5121	0.10000

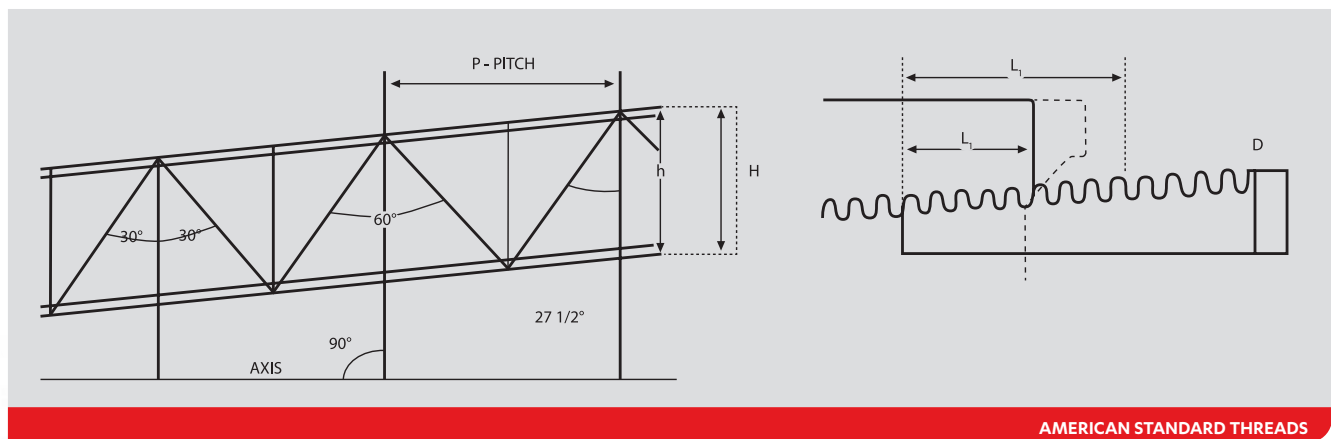

Notes:

- Straight pipe threads: the pitch, angle and depth of thread are the same as the corresponding dimensions of the taper pipe threads.
- TAPER: $L2 = (0.8D \div 6.8) 1/n$.

FLANGE TECHNICAL DATA



FLANGE

STAINLESS STEEL FLANGE TABLE

NOMINAL PIPE SIZE NB	NOMINAL PIPE SIZE INCHES	SPECIFICATION	PRESSURE RATING	FLANGE DIAMETER MM	THICKNESS MM	NUMBER OF BOLTS	DRILLING	BOLT PCD
25	1	ANSI B16.5	CL 150	108	11.5	4	16	79.4
		EN1092-1	PN 16	115	16	4	14	85
		AS 2129	TE	115	7	4	14	83
32	1.25	ANSI B16.5	CL 150	117	13	4	16	88.9
		EN1092-1	PN 16	140	18	4	18	100
		AS 2129	TE	120	8	4	14	87
40	1.5	ANSI B16.5	CL 150	127	14.5	4	16	98.4
		EN1092-1	PN 16	150	18	4	18	110
		AS 2129	TE	135	9	4	14	98
50	2	ANSI B16.5	CL 150	152	16	4	20	120.6
		EN1092-1	PN 16	165	19	4	18	125
		AS 2129	TE	150	10	4	18	114
65	2.5	ANSI B16.5	CL 150	178	17.5	4	20	139.7
		EN1092-1	PN 16	185	18	8	18	145
		AS 2129	TE	165	10	4	18	127
80	3	ANSI B16.5	CL 150	191	19.5	4	20	152.4
		EN1092-1	PN 16	200	20	8	18	160
		AS 2129	TE	185	11	4	18	146
100	4	ANSI B16.5	CL 150	229	24	8	20	190.5
		EN1092-1	PN 16	220	22	8	18	180
		AS 2129	TE	215	13	8	18	178
150	6	ANSI B16.5	CL 150	279	25.5	8	23	241.3
		EN1092-1	PN 16	285	24	8	22	240
		AS 2129	TE	280	17	8	22	235
200	8	ANSI B16.5	CL 150	343	29	8	23	298.4
		EN1092-1	PN 16	340	26	12	22	295
		AS 2129	TE	335	19	8	22	292
250	10	ANSI B16.5	CL 150	406	30.5	12	26	361.9
		EN1092-1	PN 16	395	26	12	26	350
		AS 2129	TE	405	22	12	22	356

VALVES TECHNICAL DATA

1 PIECE BALL VALVE

MATERIAL LIST		
PART NAME	SPECIFICATION	QUANTITY PER UNIT
Body	ASTM A3561 grade CF8M	1
Body Insert	SS 316	1
Joint Gasket	Teflon	1
Seat	Reinforced TFE	1
Ball	SS316	1
Thrust Washer	Teflon	1
Stem Packing	Teflon	1
Gland Nut	SS304	1
Stem	SS316	1
Handle Washer	SS304	1
Handle Nut	SS304	1
Handle	SS304	1
Handle Cover	Plastic	1

*DuPont Reg TM.



1 PIECE BALL VALVE

FEATURES

- Pressure rating 800psi.
- Temperature rating 60 to 450°F.
- End connections - threaded.
- Blow out proof end design.
- For chemical and industrial application.

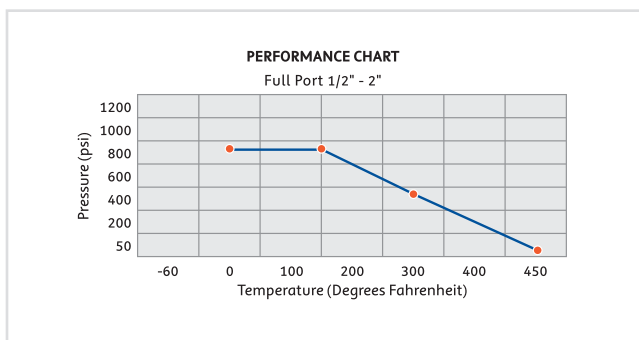

2 PIECE BALL VALVE

MATERIAL LIST		
PART NAME	SPECIFICATION	QUANTITY PER UNIT
Body	ASTM A351 grade GR.CF8M	1
End Cap	ASTM A351 grade GR.CF8M	1
Ball	ASTM A351 grade GR.CF8M	1
Seat	Reinforced TFE	1
Packing	Teflon	1
Thrust Washer	Reinforced TFE	1
Stem Packing	Teflon	1
Stem	SS316	1
Gland Nut	SS304	1
Handle Washer	SS304	1
Handle Nut	SS304	1
Handle	SS304	1
Handle Cover	Plastic	1



2 PIECE BALL VALVE

FEATURES

- Pressure rating 800psi WOG.
- Temperature rating 60 to 450°F.
- End connections - threaded.
- For chemical and industrial application.

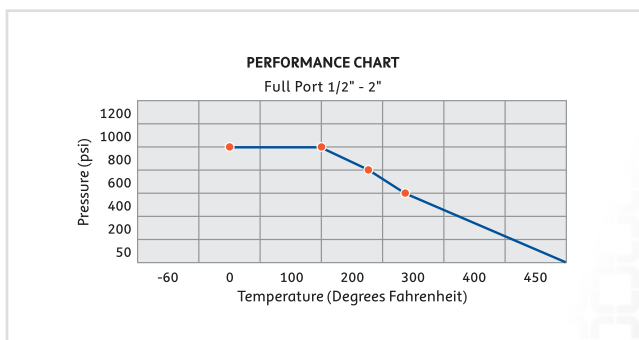

VALVES TECHNICAL DATA (CONTINUED)

3 PIECE BALL VALVE

MATERIAL LIST		
PART NAME	SPECIFICATION	QUANTITY PER UNIT
Body	ASTM A351 grade GR.CF8M	1
End Cap	ASTM A351 grade GR.CF8M	2
Body Bolts	SS316	4
Body Nuts	SS316	4
Bolt Washer	SS316	4
Ball	SS316	1
Seat Ring	Reinforced TFE	2
Thrust Washer	Reinforced TFE	1
Stem	SS316	1
Stem Packing	Teflon	3
Packing Nut	SS304	1
Handle Cover	SS304	1
Handle Washer	SS304	1
Handle Unit	SS304	1
Handle Cover	Plastic	1



3 PIECE BALL VALVE

FEATURES

- Pressure rating 1000psi WOG.
- Temperature rating 230°C.
- End connections - BSPT socket weld.
- Full flow bore.
- Blow out proof stem design.
- Allows in-line maintenance.

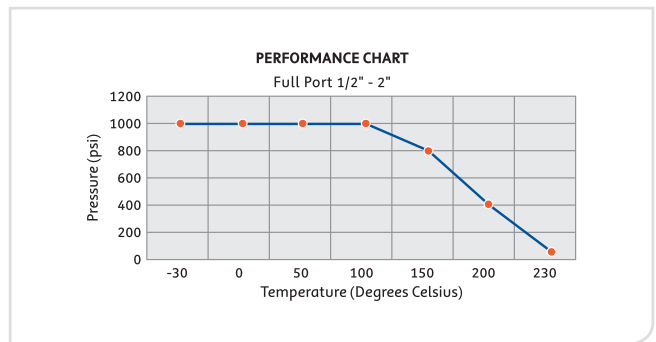

*DuPont Reg TM.

3 WAY L-PORT BALL VALVE

MATERIAL LIST		
PART NAME	SPECIFICATION	QUANTITY PER UNIT
Body	ASTM A351 grade GR.CF8M	1
End Cap	ASTM A351 grade GR.CF8M	1
Ball	SS316	1
Seat Ring	Reinforced TFE	1
Stem	SS316	1
Thrust Washer	Reinforced TFE	1
Stem Packing	Teflon	1
Joint Gasket	Teflon	1
Gland Nut	SS304	1
Handle	SS304	1
Flow Indicator Plate	Aluminium	1
Handle Washer	SS304	1
Handle Nut	SS304	1
Locking Device	SS304	1
Handle Cover	Plastic	1



KLEANFLOW 3 WAY L PORT BALL VALVE

FEATURES

- Pressure rating 1000psi WOG.
- Temperature rating 230°C.
- End connections - BSPT socket weld.
- Full flow bore.
- Blow out proof stem design.

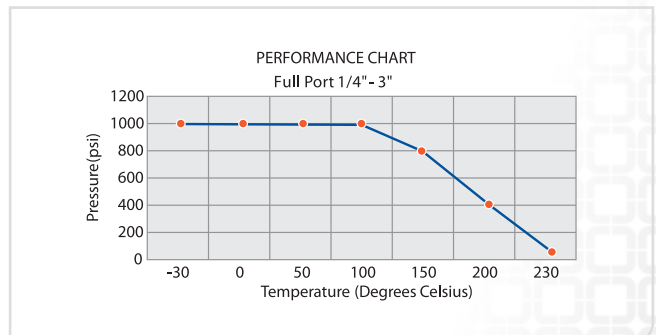

*DuPont Reg TM.

VALVES TECHNICAL DATA (CONTINUED)

GATE VALVE CLASS 200

MATERIAL LIST		
PART NAME	SPECIFICATION	QUANTITY PER UNIT
Body	ASTM A351 grade GR.CF8M	1
Disc	ASTM A351 grade GR.CF8M	1
Stem	SS316	1
Bonnet	ASTM A351 grade GR.CF8M	1
Gasket Packing	Teflon	1
Stop Ring	SS304	1
Stem Holder	SS316	1
Stem Packing	Teflon	1
Gland	SS304	1
Gland Nut	SS316	1
Hand Wheel	Steel	1
Name Plate	Aluminium	1
Hand Wheel Washer	SS304	1
Hand Wheel Nut	SS304	1



GATE VALVE CLASS 200

FEATURES

- Pressure rating 200psi WOG.
- Temperature rating 180°C.
- Connecting threads - BSPT (to BS21 spec).
- Inside screw and screwed bonnet.
- Wedge disc.
- Integral seats.
- Non-rising stem and handwheel.

GLOBE VALVE CLASS 200

MATERIAL LIST		
PART NAME	SPECIFICATION	QUANTITY PER UNIT
Body	ASTM A351 grade GR.CF8M	1
Disc	SS316	1
Stem	SS316	1
Bonnet	ASTM A351 grade GR.CF8M	1
Gasket Packing	Teflon	1
Washer	SS304	1
Stem Packing	Teflon	1
Gland	SS304	1
Gland Nut	SS316	1
Hand Wheel	Steel	1
Name Plate	Aluminium	1
Hand Wheel Washer	SS304	1
Hand Wheel Nut	SS304	1



GLOBE VALVE CLASS 200

FEATURES

- Pressure rating 200psi WOG.
- Temperature rating 180°C.
- Connecting threads - BSPT (to BS21 spec).
- Inside screw and screwed bonnet.
- Swivel disc.
- Integral seats.
- Non-rising stem and handwheel.

SWING CHECK VALVE CLASS 200

MATERIAL LIST		
PART NAME	SPECIFICATION	QUANTITY PER UNIT
Body	ASTM A351 grade GR.CF8M	1
Cap	ASTM A351 grade GR.CF8M	1
Disc	ASTM A351 grade GR.CF8M	1
Hinge Pin	SS316	1
Plug	SS316	1
Gasket	Teflon	1



SWING CHECK VALVE CLASS 200

FEATURES

- Pressure rating 200psi WOG.
- Temperature rating 180°C.
- Connecting threads - BSPT (to BS21 spec).
- Screw cap.
- Swing type disc.
- Integral seats.

TUBE BENDS – PROPERTIES AND DIMENSIONS

Available in stainless steel grades 304 and 316.

90° HYGIENIC BUTT WELD BEND – NZ DIMENSIONS

TUBE (OD) MM	31.8	38.1	44.5	50.8	63.5	76.2
TUBE (OD) INCH	1"	1 1/4"	1 3/4"	1 1/2"	2 1/2"	3"
R – RADIUS MM	57.2	76.2	79.4	101.6	114.3	139.7
A – DIM A	104.9	130.15	139.75	158.8	184.15	215.9
B – DIM B	31.8	34.9	38.1	31.8	38.1	38.1
STOCKED	YES	YES	YES	YES	YES	YES

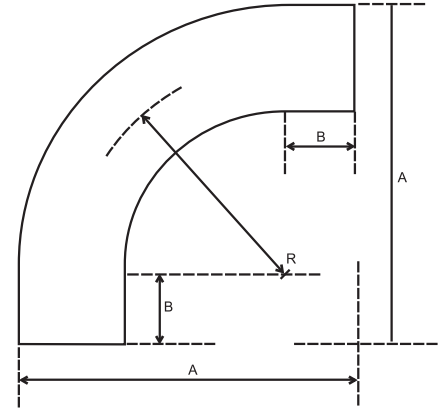

90° HYGIENIC BUTT WELD BEND TO AS1528

TUBE (OD) MM	12.7	15.9	19.1	25.4	31.8	38.1	50.8	63.5	76.2	101.6	152.4
TUBE (OD) INCH	1/2"	5/8"	3/4"	1"	1 1/4"	1 1/2"	2"	2 1/2"	3"	4"	6"
RADIUS	19.05	23.8	28.65	38.1	47.6	57.2	76.2	95.3	114.3	152.4	228.6
DIM A	55.4	61.7	68.2	80.8	93.5	106.2	131.6	157.1	182.4	233.4	344.8
DIM B	30.0	30.0	30.0	30.0	31.8	34.9	31.8	38.1	38.1	30.0	40.0
STOCKED	YES	YES	YES	YES	NO	NO	NO	NO	NO	YES	YES

180° HYGIENIC BUTT WELD BEND – NZ DIMENSIONS

TUBE (OD) MM	25.4	31.8	38.1	50.8	63.5	76.2	101.6
TUBE (OD) INCH	1"	1 1/4"	1 1/2"	2"	2 1/2"	3"	4"
R – RADIUS MM	44.5	57.2	76.2	101.6	114.3	139.7	152.4
A – DIM A	79.4	104.9	130.2	158.8	184.2	215.9	233.2
B – DIM B	22.2	31.8	34.9	31.8	38.1	38.1	30.0
STOCKED	YES	YES	YES	YES	YES	YES	YES

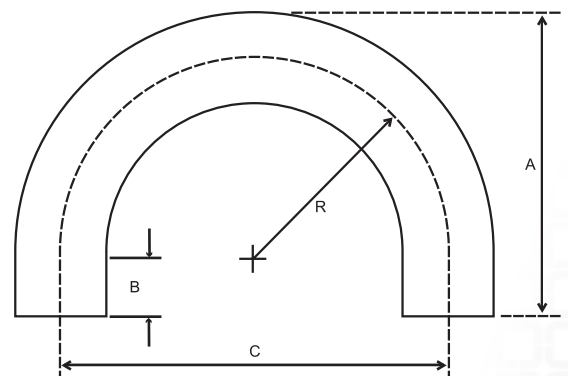

180° HYGIENIC BUTT WELD BEND TO AS1528

TUBE (OD) MM	25.4	31.8	38.1	50.8	63.5	76.2	101.6
TUBE (OD) INCH	1"	1 1/4"	1 1/2"	2"	2 1/2"	3"	4"
R – RADIUS MM	38.1	47.6	57.2	76.2	95.3	114.3	152.4
A – DIM A	80.8	93.5	106.3	131.6	157.1	182.4	233.2
B – DIM B	30.0	30.0	30.0	30.0	30.0	30.0	30.0
STOCKED	NO	NO	NO	NO	NO	NO	NO

TUBE BENDS – PROPERTIES AND DIMENSIONS (CONTINUED)

Available in stainless steel grades 304 and 316.

45° HYGIENIC BUTT WELD BEND TO AS1528.3

TUBE (OD) MM	19.1	25.4	31.8	38.1	50.8	63.5	76.2	101.6	152.4
TUBE (OD) INCH	3/4"	1"	1 1/4"	1 1/2"	2"	2 1/2"	3"	4"	6"
RADIUS	28.65	38.1	57.2	57.2	76.2	95.3	114.3	152.4	228.6
DIM A	110.5	123.0	136.0	148.0	174.0	199.0	225.0	275.0	401.4
DIM B	30.0	30.0	30.0	30.0	30.0	30.0	30.0	30.0	40.0
STOCKED	YES	YES	YES	YES	YES	YES	YES	YES	YES

45° LONG LEG HYGIENIC BUTT WELD BEND

TUBE (OD) MM	31.8	38.1	50.8	63.5
TUBE (OD) INCH	1 1/4"	1 1/2"	2"	2 1/2"
RADIUS	57.2	76.2	101.6	114.3
DIM A	188.5	227.8	281.0	361.2
DIM B	47.8	54.9	63.8	89.1
STOCKED	NO	YES	YES	YES

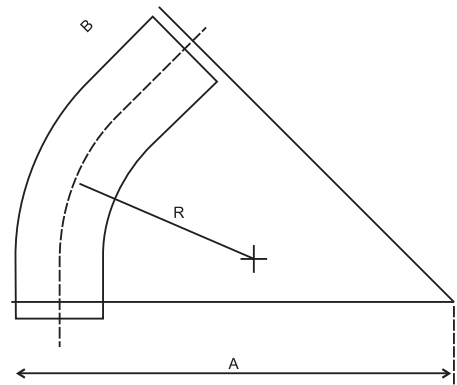

90° LONG LEG HYGIENIC BUTT WELD BEND

TUBE (OD) MM	25.4	31.8	38.1	50.8	63.5	76.2	101.6
TUBE (OD) INCH	1"	1 1/4"	1 1/2"	2"	2 1/2"	3"	4"
RADIUS	38.1	57.2	57.2	76.2	95.3	114.3	152.4
DIM A	123.0	136.0	148.0	174.0	199.0	225.0	275.0
DIM B	30.0	30.0	30.0	30.0	30.0	30.0	30.0
STOCKED	YES	YES	YES	YES	YES	YES	YES

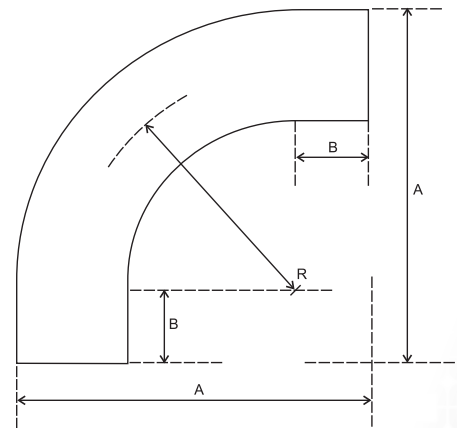

90° SHORT RADIUS HYGIENIC BUTT WELD BEND

TUBE (OD) MM	25.4	31.8	38.1	50.8	63.5	76.2	101.6	127
TUBE (OD) INCH	1"	1 1/4"	1 1/2"	2"	2 1/2"	3"	4"	5"
RADIUS	38.1	47.6	57.2	76.2	95.3	114.3	152.4	190.5
DIM A	50.8	76.2	76.2	101.6	127.0	152.4	203.2	254.0
DIM B	0	12.7	0	0	0	0	0	0
STOCKED	YES	YES	YES	YES	YES	YES	YES	YES



STRONGER IN EVERYWAY



To find out more about our extensive range of products and services:

- › Steel
- › Pipe, Fittings & Valves
- › Stainless Steel
- › Fastenings
- › Chain & Rigging
- › Rural Products
- › Industrial Products
- › Reinforcing
- › Roofing, Cladding, Rainwater Systems & Purlins

CONTACT US TODAY:

0800 478 335

www.steelandtube.co.nz